



U95

OPERATING INSTRUCTIONS

This product supports GPS positioning and is recommended for outdoor flight!
* This wifi camera pinpoint is 5G, please confirm whether the phone is supported.

V1.0

Note

- ▲ This product is suitable for users over 14 years old.
- ▲ Stay away from the rotating propeller



Li-Po Battery Disposal & Recycling

Wasted Lithium-Polymer batteries must not be placed with household trash. Please contact local environmental or waste agency or the supplier of your model or your nearest Li-Po battery recycling center.



**Important
Notice**

Our company's products are improving all the time, design and specifications are subject to change without notice. All the information in this manual has been carefully checked to ensure accuracy, if any printing errors, our company reserve the final interpretation right.

Drone preparation

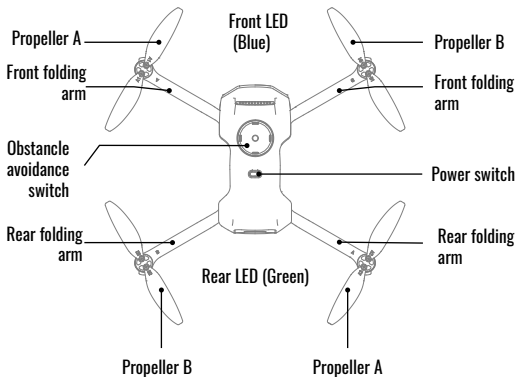

Obstacle avoidance switch

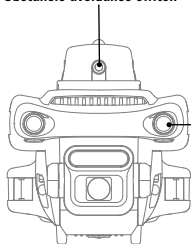

Front Camera

Front LED (Blue)

Optical flow position

Battery

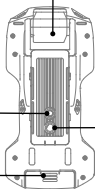

Fill light switch

Unfolding Instruction

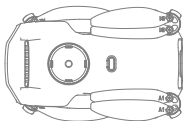

① Folding State

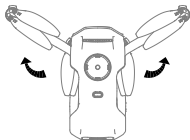

② Front folding arms unfold

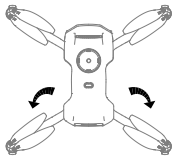

③ Rear folding arms unfold

Drone battery charging

Battery power is low in the original factory, It must be fully charged before use.

Connect the batteries of the drone to the charging line of the original plant, and then connect to other USB charging sockets.

The indicator of drone battery is keep red when charging.
The indicator of drone battery is keep green when fully charged.

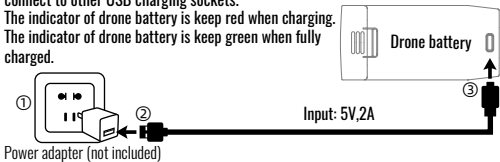

▲ Only use the original USB charging cable.

Warning: Must be attended to while charging

Installation of drone battery

Place the battery into the battery compartment along the rear of drone.

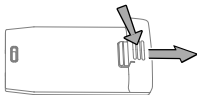
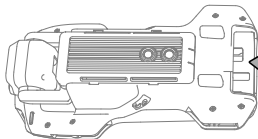

Disassem:
Pull out the battery
Press to unlock the lock

Transmitter preparation

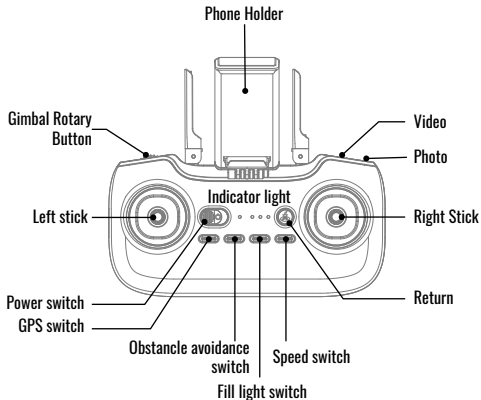

Transmitter charging

Battery power is low in the original factory, It must be fully charged before use. Connect the transmitter with the charging line of the original plant, and then connect other USB charging outlets. When charging, the transmitter indicator flashes circularly, and when charging is completed, the indicator will be on for a long time.

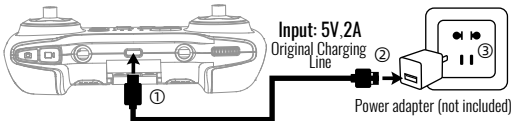

▲ Only use the original USB charging cable.

Warning: Must be attended to while charging

Installation of phone holder and phone

Installation

① Straightening the antenna



② Put the phone clip on the back of the quasi-remote controller and push it to the end.

③ Pull up the clip on the mobile phone.

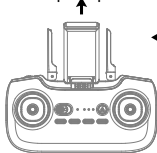

④ Place the phone in the upper and lower clamps. Between the clamp will automatically clamp the mobile phone.

Disassemble

② Pull up the clip on the mobile phone

① Press to unlock the lock



Notice: Don't clip the buttons on the side of the phone.

Flight Operations

Mobile phone connect with Drone

Download and install APP: RC-Wing

This software is suitable for mobile phones in the IOS 9.0 or later and Android 4.4 or later system. For detailed operation, please check the system "HELP" of APP.



Transmitter connect with Drone

Frequency Pairing

- ① Turn on the power.

it indicates the transmitter enters the frequency state.

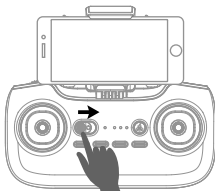

Horizontal Ground

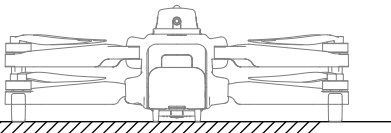

- ② The drone is placed on the horizontal ground, long press the power button for 3 seconds to turn on, the front and rear navigation lights cycle flashing, indicating that the frequency alignment is successful to enter the GPS start search state.

Compass calibration

Rotate the drone horizontally until the transmitter sounds "di... "Level correction to complete. When the front navigation light turns to long light and the rear navigation light flashes, enter vertical correction. Rotate the drone vertically until the transmitter sounds "di... "A sound, vertical correction over. The lights are spinning and flashing.

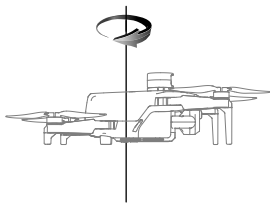

Horizontal rotation

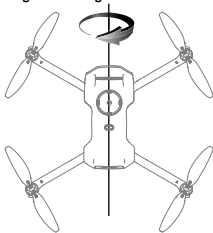

Vertical rotation

Tips: It's a must to have the right compass adjustment first each time you start the drone, or it can't work normally

Gyroscope Calibration



After the calibration of the compass, the right stick of the transmitter is pushed to the lower right corner by 45°, and the transmitter emits sound "di", and the drone light flashes and releases, indicating that the gyroscope has been calibrated. (drone should be placed on horizontal ground)

Tips: When the drone doesn't appear to use the trim correction flight status, or being hit hard (or falling abnormally). thus cause the difficulties in controlling. Now frequency making and adjustment are needed again.

GPS Signal Search

After the frequency matching is successful, the drone automatically searches for GPS signals. When the blue indicator light of the remote control changes from flashing to long bright, it makes a sound of "di" at the same time, indicating that the GPS connection is successful. (when the GPS signal is weak or flying indoors, the flight height defaults to about 4 meters)

!GPS must be turned off when flying indoors.

Unlocking/locking the motor



Push the left and right stick inward to the 45° angle simultaneously.

- ① On standby drone, motor rotation, drone unlocked.
- ② When the drone is not take off, the motor stops rotating and the drone is locked.

The drone can only take off when the motor is unlocked.

Take off

After unlocking the motor, the left stick slowly pushes up and the drone slowly rises.



Landing

During the flight, the left stick slowly pull down , and the drone slowly lands until landing.



Control stick operation

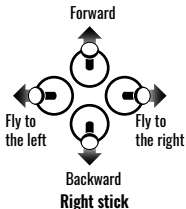
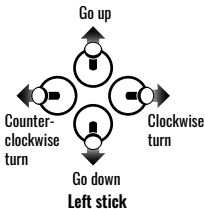

Return

During the flight, press the "  " button, and the transmitter will sound "di", and the drone will automatically return to the take-off point. (during returning, the transmitter will continuously sound "di". To stop homing, just press this button again.)



Notice: While returning, the control lever of the transmitter can not control the drone, it must be waited for the drone to go back to the take-off point. And after the direction of the drone is directed at the direction of taking off, in this way right stick can control the drone.

GPS ON /OFF

GPS is on by default.

GPS OFF: Press the "  " button, the transmitter will sound "di" and the blue indicator of the transmitter will go off, it means GPS will be off.

GPS ON: Press the "  " button and the blue indicator of the transmitter will keep bright. It means GPS restart.

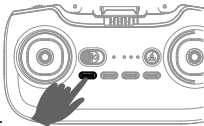

Note: this function is only used when the motor is locked.

Speed mode switch

Medium speed default

Press "H/L" button, the transmitter will sound "di.di.di" to enter high speed mode "H".

Press it again, the transmitter will sound "di" to enter low speed mode "L".

Press it again, the transmitter will sound "di.di" to enter medium speed mode "M".



Gimbal Adjustment

Roll Gimbal Rotary Button, adjust Camera Angle.

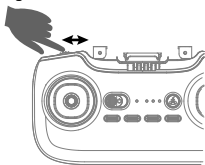

Photo

Press the "  " button once to take a picture and the transmitter will sound "di".

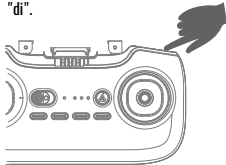

Video

Press the "  " button, the transmitter will sound "didi" to start recording. Repeat this action to stop recording and save the video.

- ① The APP must be authorized to read the phone gallery to view the aerial photos.
- ② When aerial video is read by computer, it must have corresponding playback software.

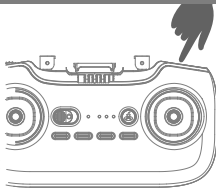

Fill light switch

The fill light is off by default. Press the “☀️” button, the transmitter will sound “di” to turn on the fill light, and press again to turn off.



Obstacle avoidance switch

Obstacle avoidance mode is off by default. Press the “👁️” button, the transmitter will sound “di” to turn on the obstacle avoidance function, and press again to turn avoidance function.



Note: Switch to high speed switch, obstacle avoidance function will be disabled.

Low Battery Alarm

When the transmitter in low battery, the transmitter will continues to sound “di...di...di.....” to remind the user to return home and charge the batteries of the transmitter as soon as possible.

Automatic Return

When the drone in low battery, the transmitter will continues to sound “dididi..... dididi”, the drone’s indicator lights turn from long to bright. After alarming you, the drone automatically returned to the take-off point.

Out of range alarm

When the drone is out of the remote control distance, the transmitter will continue to sound "didi.didi" to alarm the user to return the drone immediately.

Stuck Protection

When the propeller is stuck and does not rotate, the drone will start the automatic protection function to stop the motor working.

Out of Control Protection

Out of control protection refers to the flight control system automatically controls the drone to fly back to the return point after receiving the remote control signal (ie, out of control), the drone does not have the function of avoiding obstacles during the uncontrolled return flight. The user can set the return altitude value to avoid obstacles on the way back.

Possibility of entry into runaway protection mode

- * The remote control is off.
- * Flight distance exceeds the effective distance of remote control signal transmission.
- * There is an obstacle between the transmitter and the drone.
- * Transmitter signal is disturbed.

Attention

- ① Switching sequence. At first, turn on the power of the transmitter, then turn on the power of the drone. After the end, turn off the power of the drone first, and then turn off the power of the transmitter.
- ② Improper operation caused the crash. It is necessary to check and confirm the connection of the motor, blade or electric pool of the drone and the damage degree, so that the drone can fly again.
- ③ If it is damaged, please replace it with new accessories, otherwise it will easily cause flight accidents. Battery must be removed when the drone is not in use.

Parts Replacement

Propeller Replacement

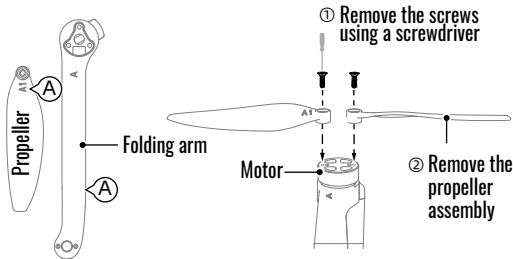

Remove propeller components in serial order. Operation in the opposite direction during installation. The propeller is divided into AB, corresponding to the letter on the folding arm. Please make sure it is installed correctly, otherwise it cannot fly.

Troubleshooting

Problem	Solution
The transmitter indicator light is off	1) The battery is low, please charge in time.
	2) Please make sure turn on the power.
Unable to frequency	1) Please refer to the manual to operate again.
	2) Make sure signal interference nearby and keep away.
	3) The electronic component is damaged for frequent crash.
Under-powered or can not fly	1) Make sure the propeller is damaged or replace a new one.
	2) When the battery is low, please charge it in time.
Abnormal flight cannot altitude hold and yaw serious	1) Make sure the propeller is it damaged ? If so, replace the propeller.
	2) Confirm whether the body shell is damaged and replace it.
	3) Restart and "correct" according to the instructions after 10 seconds of shutdown.
The drone indicator light is off	1) When the battery is low, please charge it in time.
	2) Replace the damaged battery with a new one.
	3) Over-powered protection, restart after 30 seconds of shutdown.

FCC Note

This equipment has been tested and found to comply with the limits for a Class B digital device, pursuant to Part 15 of the FCC Rules. These limits are designed to provide reasonable protection against harmful interference in a residential installation. This equipment generates uses and can radiate radio frequency energy and, if not installed and used in accordance with the instructions, may cause harmful interference to radio communications. However, there is no guarantee that interference will not occur in a particular installation. If this equipment does cause harmful interference to radio or television reception, which can be determined by turning the equipment off and on, the user is encouraged to try to correct the interference by one or more of the following measures:

- Reorient or relocate the receiving antenna.
- Increase the separation between the equipment and receiver.
- Connect the equipment into an outlet on a circuit different from that to which the receiver is connected.

WARNING: Changes or modifications not expressly approved by the party responsible for compliance could void the user's authority to operate the equipment.

The equipment may generate or use radio frequency energy. Changes or modifications to this equipment may cause harmful interference unless the modifications are expressly approved in the instruction manual. Modifications not authorized by the manufacturer may void user's authority to operate this device.

This device complies with Part 15 of the FCC Rules. Operation is subject to the following two conditions:

- (1) This device may not cause harmful interference.
- (2) This device must accept any interference received, including interference that may cause undesired operation.

FCC Radiation Exposure Statement

The device has been evaluated to meet general RF exposure requirement. The device can be used in portable exposure condition with out restriction.

WARNING

Warning: The product should only be used by adults and children over 14 years.
Adult supervision is required for children under 14 years.

Hinweis: Dieses Produkt ist für die Erwachsene und die Kinder ab 14 Jahren.
Die Kinder unter 14 Jahren müssen von Erwachsenen beaufsichtigt werden.

Avertissement: Ce produit est destiné aux adultes et aux enfants de plus de 14 ans.
Les enfants de moins de 14 ans doivent être surveillés par des adultes.

Avvertimento: Questo prodotto è destinato all'uso per i adulti e bambini di età superiore ai 14 anni. I bambini di età inferiore ai 14 anni devono essere sorvegliati da un adulto.

Advertencia: Este producto es para adultos y niños mayores de 14 años.
Los niños menores de 14 años deben ser supervisados por adultos.

警告: この製品は、大人と14歳以上の子供には使用対象です。
14歳未満の子供は大人の監視が必要です。



DANGER!
Only suitable for age 14+



Manufacturer: UDIRC TECHNOLOGY CO., LTD

Address: Guangfeng Industrial Zone, Guangyi Street, Changhai District, Shantou City, Guangdong Province, CN

MADE IN CHINA