

Please read this manual carefully before assembling and or disassembling your vehicle.

INSTRUCTION MANUAL

1/10TH SCALE 2WD ELECTRIC POWERED OFF ROAD BUGGY

TWO WHEEL DRIVE RACING

-BRUSHED VERSION

-BRUSHLESS VERSION

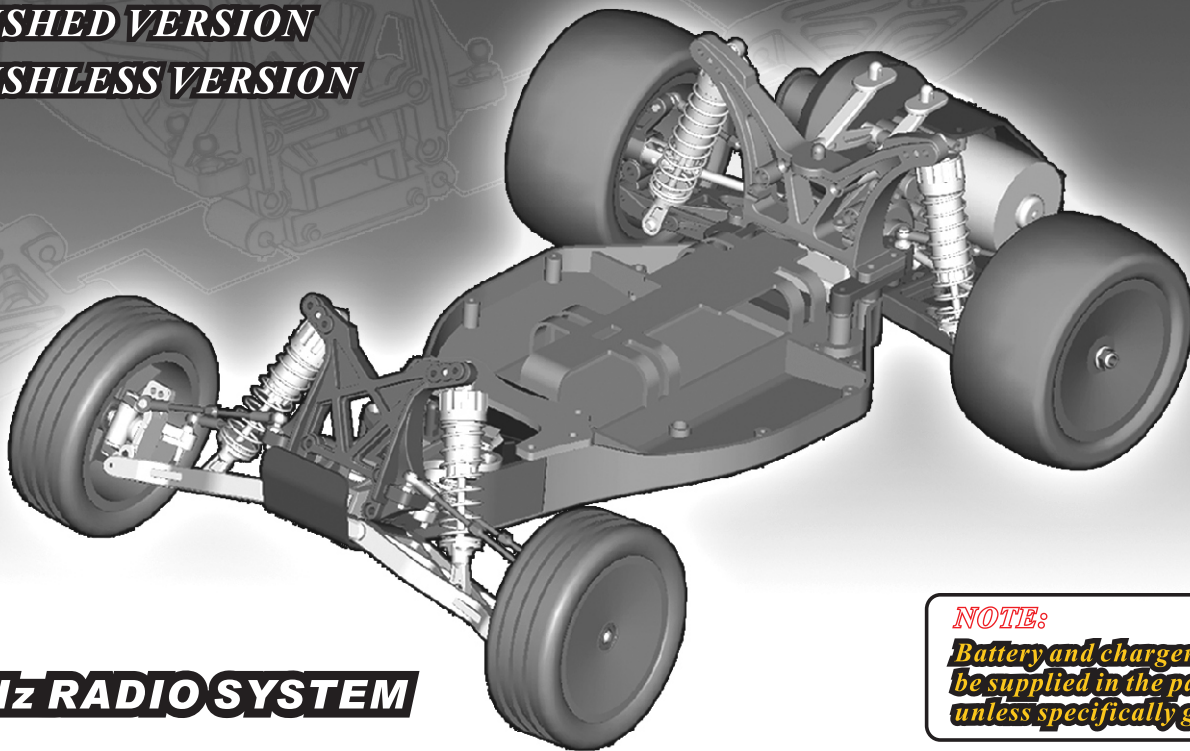

2.4GHz RADIO SYSTEM

NOTE:

Battery and charger may not be supplied in the packaging, unless specifically given

TECHNICAL DATA & MAIN FEATURES

This is a new generation 1-10th scale 2WD off road vehicle. It is build in RTR version at factory. It is also made in two versions (brushed version and brushless version). The following are the specifications for motors and speed controllers.

Brushed ESC: 100A, (Max. voltage: 7.4V)
Brushed motor: RC540 (20000rpm) **Brushed Version**

Brushless ESC: 90A, (voltage: 7.4V-12V)
compatible for sensor/sensorless brushless motor **Brushless Version**
Brushless motor: KV 3930

- Length: 405mm
- Height: 135mm
- Width: 250mm
- Wheelbase: 265mm
- Wheel Width: 29mm (front wheel)
43mm (rear wheel)
- Wheel Dia.: 81mm (front wheel)
85mm (rear wheel)
- Gear Ratio: 1:8.8 (brushed),
1:9.6 (brushless)
- Net Weight: 1.195kg (battery not included)

SAFE INFORMATION

- Read carefully and fully understand the instructions before commencing assembly and/or disassembly.
- This R/C vehicle is intended for persons over 14 years of age. Children under 14 years of age should only operate this car under adult supervision.
- When assembling this kit, tools including knives are used. Extra care should be taken to avoid personal injury.
- Read and follow the instructions supplied with all tools (not included in kit).
- Keep out of reach of little children. Children must not be allowed to put any parts in their mouth, or pull vinyl bag over their head.

GENERAL WARNINGS

- Under no circumstances should you operate your car in crowds of people. Serious injury could result.
- Never operate your car on any public streets. This could cause traffic accidents, personal injury and/or property damage. The car is only allowed to be driven on the track where is for RC cars.

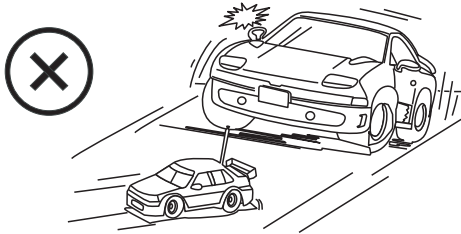

- Do not use your car to chase pets or other animals.
- The receiver, steering servo and other electronics installed in your car are not waterproof; therefore, do not drive through water, wet grass, mud or snow.
- Because your car is operated by radio control, it is important to make sure you are always using fresh and/or fully charged batteries. Never allow the batteries to run low in the radio controller or you could lose control of your car.
- If your car becomes stuck, release the throttle, then retrieve it by hand.
- Do not continue to apply the throttle or you may damage the motor and/or the ESC (electronic speed controller).
- Before running your car, check the battery wiring and plugs are not loose. Otherwise, it could cause damage to your car when running.

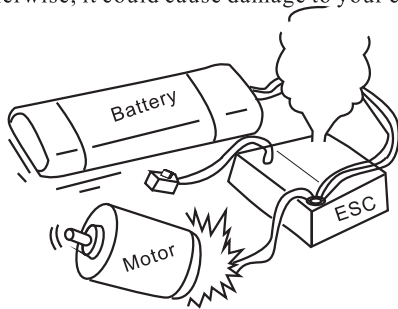

- Before running your car, make certain to adjust the stop, low, middle, and top speed positions of your car.
- A worn motor will overheat and result in a short running time.
- Replace a worn out motor as soon as possible.



Any malfunction incurred by contrived upgrading and modification will void warranty.

Brushed ESC on this kit stands only 7.4V (2 cell) lipo battery.

Brushless ESC on this kit stands only 7.4-11.1V (2-3cell) lipo battery.

RADIO CONTROL SYSTEM WARNINGS

- If you are testing the motor, be careful not to touch any moving parts. Serious injury could result.
- To prevent excessive r.p.m.'s from damaging the motor and/or the drivetrain components, we suggest reducing the throttle while in the air during jumps.
- It is normally the case that the car runs slower when it is going uphill. It does not mean anything wrong with the car.
- Never attempt to re-assemble motor, ESC, and receiver which have been well adjusted at factory.
- Always apply our recommended optional parts to your car.
- To upgrade your car allows you to upgrade the whole system (such as motor, ESC, receiver and the like). They should be well matched.
- When turning on your car, always turn ON the radio control before turning ON the receiver.
- When turning off your car, always turn OFF the receiver before turning OFF the radio control.
- Never cut the receiver antenna shorter or you could lose control of your car.
- When operating your car, make sure the radio control's antenna is completely extended.

BATTERY/CHARGER WARNINGS

- Always unplug the battery pack when not in use.
- Always allow the battery to completely cool before recharging.
- Never over-charge the battery or serious damage to the battery and/or the user could result.
- Periodically check the battery for excessive heat build-up during the charging process. If the battery is hot to the touch, remove it from the charger and let it cool. Never leave the battery unattended during the charging process.
- Do not dismantle or modify the battery or charger. No user serviceable parts are inside.
- Never charge your battery unattended.

GENERAL INFORMATION

- ◆ Thank you for selecting our 1-10th scale 2WD car. It is designed to be fun to drive and uses top quality parts for durability and performance.
- ◆ This is a high performance R/C kit, and it requires regular maintenance for best performance. Failure to do so will harm performance. In the last pages of this manual there are a complete list of spare parts on sale to keep your car performing at its best.
- ◆ This product is not a toy. It is not suitable for users under 14 years old unless they are supervised by adults.
- ◆ Never attempt to re-assemble the motor , ESC, and receiver. These have been carefully calibrated at the factory.
- ◆ Only use manufactured parts to upgrade your car. If you perform a drive train upgrade, replace the entire system (Such as motor, ESC, receiver and the like) so that all components are properly matched. Any malfunction incurred by custom modification will void your warranty.

SAFETY CAUTIONS

Before Running:

- Please read and understand all instructions carefully (Not suitable for operators under 14 years of age, unless closely supervised by an adult.
- Regular check is a must for your car. (Especially for tightness of wheels, screws, nuts and bearings...)
- Always use fresh batteries for your transmitter and receiver to avoid losing control of your car.
- Please confirm the neutral throttle trigger position.
- Keep in mind that before running you must turn on the transmitter first, then the receiver.

While operating

- Never run on a public street, this could cause serious accidents, personal injuries and/or damage to properties.
- Never run near pedestrians or small children.
- Never run in small or confined areas.
- Never keep close to the operators using same frequencies at the same time. Failure to do so will cause lose of control of your cars.

After Running:

- Keep in mind that before running you must turn off the receiver first, then the transmitter.
- It is necessary for you to perform routine maintenance. Failure to do this can result in increased wear and harm the performance.
- Remove battery from the car if it is not in use in a long period. Also, remove batteries from transmitter if not in use.
- Check all wires and connectors (on motor , on ESC and on battery). If damaged replace and repair them immediately.
- Never touch motor just after running as it can cause burn.

PACKAGING INCLUDED:

- ◆ One RTR 2WD off road car w/body installed,battery and charger are not included
- ◆ One Radio Control
- ◆ One English instruction manual
- ◆ Antenna Pipe

Please charge your battery before running. And, install AA size batteries (not included) to your remote controller.

ASSEMBLY KIT REQUIRED (NOT INCLUDED IN THE PACKAGING):

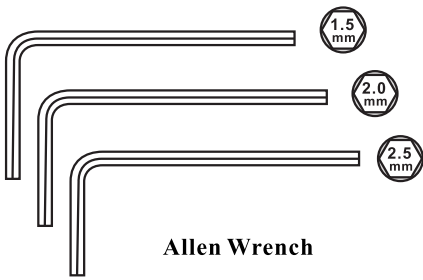

Allen Wrench

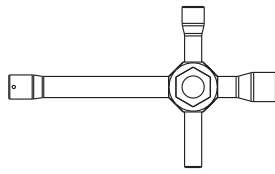

Cross Wrench (Large)
(8 /9 /10 /12mm)

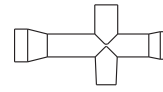

Cross Wrench (Small)
(2 / 2.5 / 3 /4mm)

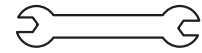

Turnbuckle Wrench

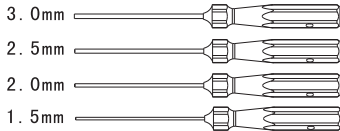

Screw Driver

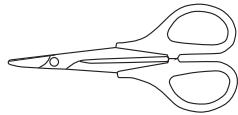

Curve Head Scissors

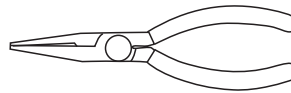

Acutilingual Plier

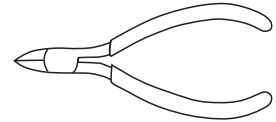

Body Cutter

RADIO INTRODUCTION

FUNCTIONS OF SWITCHES



A: Steering Wheel

B: Trigger

C: Basement (Battery Case)

1: Steering Trim

2: Steering Reverse

3: Red Indicator

4: Power Switch

5: Steering Dual Rate

6: Throttle Trim

7: Throttle Reverse

8: Green Indicator

9: Bind(Pair) Key

Steering Wheel: It proportionally operates the model's right and left steering control.

Basement(Battery Case): It requires 3pcs of AA size batteries, which are not included in the package.

Power Switch: It is used to turn the radio controller ON/OFF

Steering Dual Rate Dial: It allows you to change the amount of steering servo travel compared to the amount of physical movement of the steering wheel.

Trigger: It controls the speed and braking ability of your car. Pull it to accelerate, release it to decelerate, and push it to brake. Pushing it a second time activates the reverse feature.

FUNCTIONS OF SWITCHES

Throttle/Steering Trims: They are made to adjust the center trim of the throttle/steering channel.

Steering Reverse: It allows you to electronically switch the direction of steering servo travel. For example, if you move the steering wheel to the right and the steering servo moves to the left, flip the Steering Reverse Switch to make the steering servo move to the left.

Throttle Reverse : It allows you to electronically switch the direction that the motor operates in relation to the throttle trigger. For example, if you pull the throttle trigger to accelerate forward, but the model goes in reverse, flip the Throttle Reverse Switch to make the model accelerate forward.

Bind(Pair) Key: It is used to bind your 2.4GHz radio system.

Indicators: It shows battery power level. Green indicator flashing means battery power is not enough . As long as both red and green indicator goes flashing indicating that the radio controller runs out of battery power, you must replace with fresh batteries immediately.

BATTERY INSTALLATION

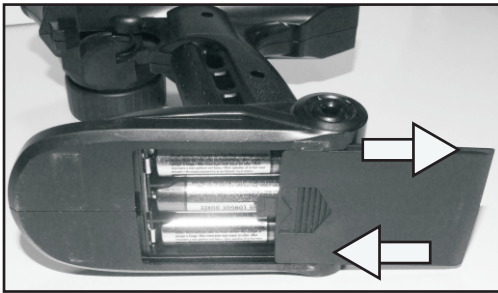

- 1) Slide the battery cover as shown , and according to the illustrations of polarities, install 3pcs of AA size batteries.
- 2) Replace the battery cover after batteries are installed.

NOTES:

- Use batteries of same type.
- Remove batteries from the case if not in use.
- Always check the battery power.
- Dispose of exhausted batteries properly.

2.4GHz RECEIVER



BIND BUTTON
ON RECEIVER



- 1 • Channel 1 to steering servo
- 2 • Channel 2 to ESC (or throttle servo)

Press the BIND button a second time to activate FAIL SAFE feature by the time the binding process is completed.

BINDING OPERATION

Perform the binding operation ,following the instructions below .

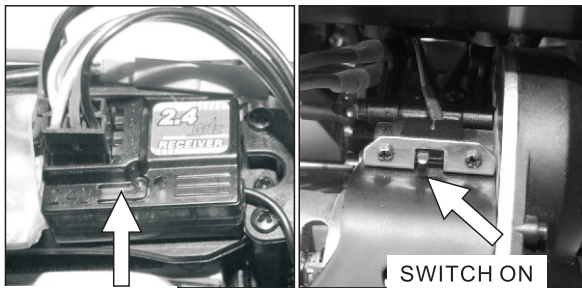

PRESS AND HOLD IT

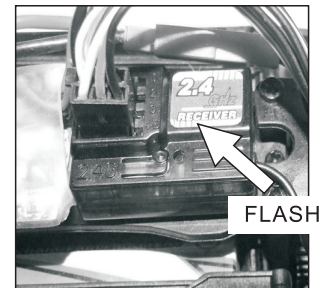

FLASH

- 1) Press and hold the Bind Button which is located on the receiver, switching on the power.
(The image may vary from your received model)

- 2) Release the Bind Button on the receiver immediately the indicator flashes rapidly.

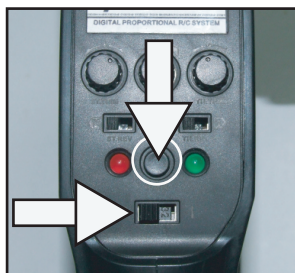

- 3) Press and hold the Bind(Pair) button on the radio controller, switching on the radio controller. Green indicator goes flashing, meaning that the binding process is being performed in system.

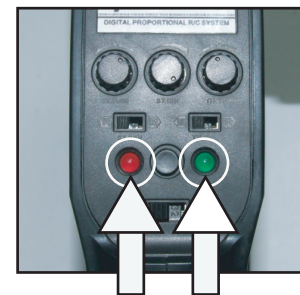

- 4) Red and green indicators being steady on means that your receiver is bound to your radio controller. Binding process is completed.

NOTE: The radio controller should be switched on no more than 5 seconds after the receiver is turned on.

SERVO INSTALLATION

Your 1-10th Scale 2WD electric powered off road vehicle has been fully assembled at factory. The following are illustrations for the users to re-assemble and/or disassemble the servo when necessary.

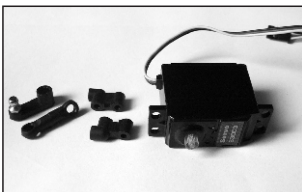

Servo linkage, servo arm, servo mount and servo are prepared.

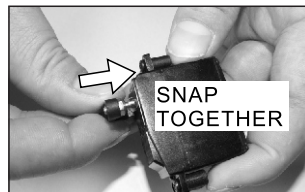

Install servo arm to servo.



Secure the servo arm with a screw (Part Number: S018)

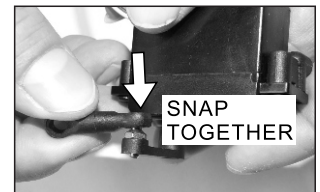

Install servo linkage to servo arm.

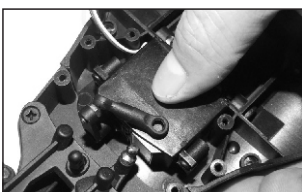

Put the servo in place on the chassis.

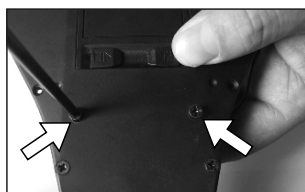

Secure the servo from the chassis bottom with two screws(Part Number: S019)

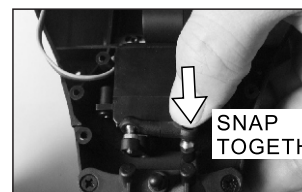

Install servo linkage to steering bush.

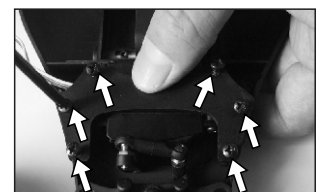

Install servo linkage to steering bush.

MOTOR INSTALLATION

Your 1-10th Scale 2WD electric powered off road vehicle has been fully assembled at factory. The following are illustrations for the users to replace a motor if required . (Brushless motor installation is identical to that of burshed motor.)

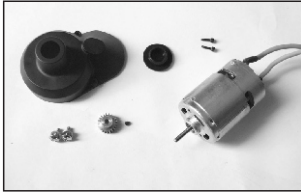

Collect all parts as shown to prepare installation.

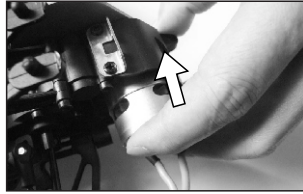

Put the motor in place as shown.

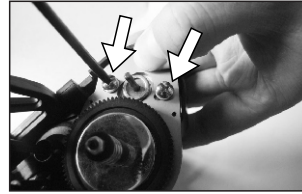

Secure the motor with two screws (Part Number:S127)

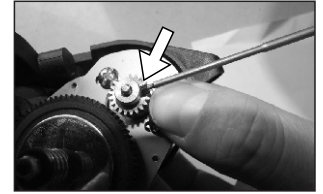

Install the motor pinion gear to the motor shaft and secure it with a screw (Part Number: S016)

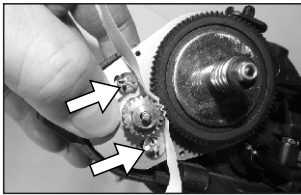

Loose the two screws , then slide a notebook paper between motor pinion gear and spur gear until the paper crinkles.

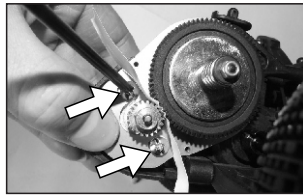

Re-tighten the two screws. Make sure the pinion gear and the spur gear are in-line.

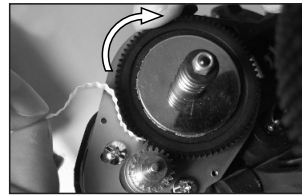

Remove the paper and double -check the gear mesh.

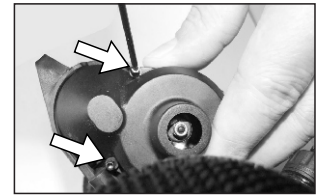

Fasten the gear cover with two mounting screws (Part Number: S031)

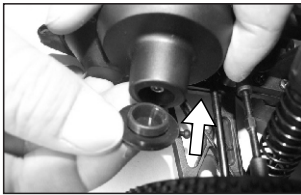

Attach the access plug to the gear cover.

| NOTES |

If the gear mesh is set properly, you should feel a very small amount of play between the two gears. If there is an excessive amount of play or no play at all, re-adjust the gear mesh again.

ELECTRONIC SPEED CONTROL (ESC) INSTALLATION

Your 1-10th Scale 2WD electric powered off road vehicle has been fully assembled at factory. The following are illustrations for the users to replace ESC if required . (Brushless motor installation is identical to that of burshed motor.)

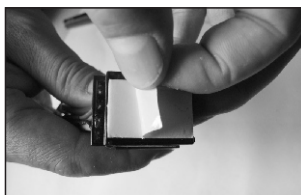

Label a piece of double side adhesive tape on your ESC bottom.

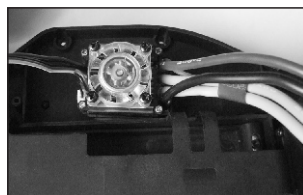

Paste your ESC on the chassis.

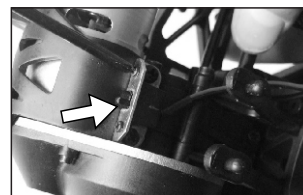

Install the receiver switch which is linked to your ESC and secure it with two screws.(Part number : S120)

RECEIVER INSTALLATION

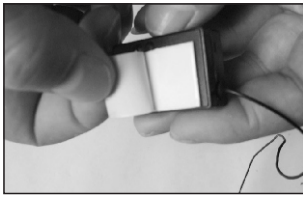

Label a piece of double side adhesive tape on the bottom of your receiver.

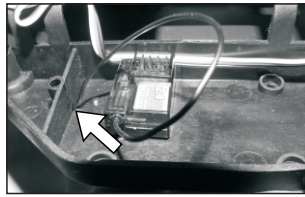

Paste your receiver in place, and slide the receiver antenna wire into the hole as shown.

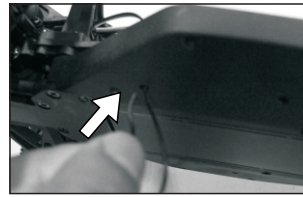

Re-slide the wire again from the chassis bottom as shown.

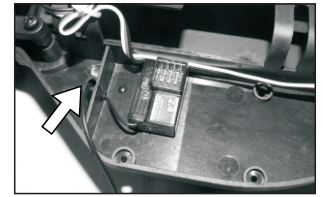

The receiver antenna should go out of the antenna mount from the chassis bottom as shown.

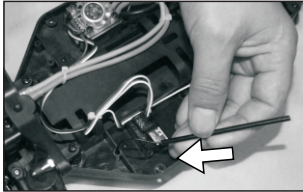

Slide the receiver antenna wire into one end of the antenna pipe and out the other end. Attach the antenna cap when ready.

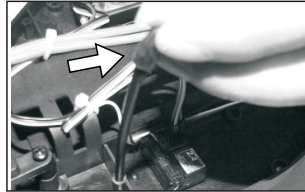

Attach the antenna cap as shown in the picture.

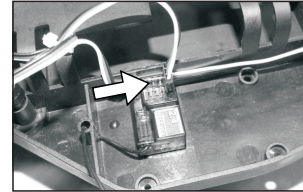

Insert the servo connector into the Slot 1 on the receiver.

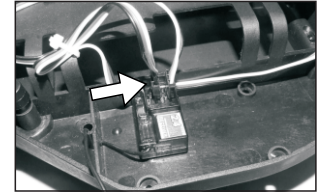

Insert the ESC connector into the Slot 2 on the receiver.

CHECKING ALL WIRES AND CONNECTORS

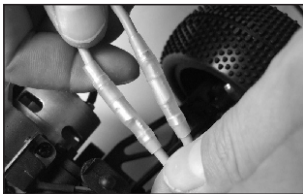

Connect motor to ESC. (yellow to yellow, blue to blue).

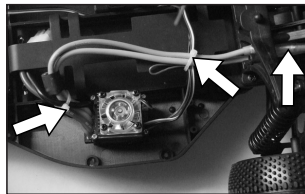

Keep all wires and connectors unloose. Fasten them with the zip ties as shown.

PREPARATION BEFORE DRIVING YOUR VEHICLE

1 Install the battery pack to your vehicle.

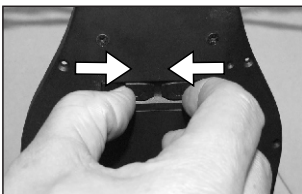

Pinch the battery cover as shown to open it.

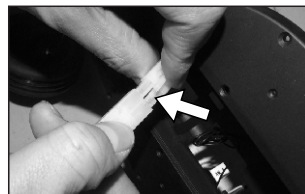

Connect the battery to your ESC.

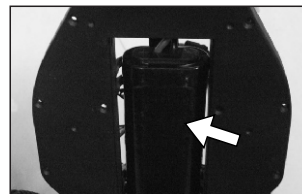

Put the battery in place.

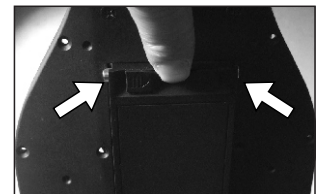

Replace the battery cover and press it until it snaps together with the chassis.



WARNING

Never tempt to use this charger to charge the batteries of your transmitter.

- Use only the specified charger (7.2V,500mA) to charge your battery pack when Ni-MH or Ni-CD battery is used. Please use with the special lipo battery charger when you use with a lipo battery.
- For better battery performance please discharge your battery before charging it.
- Never charge your battery over 4-5 hours.
- Never charge the battery pack unattended.
- Always use the battery after it is fully charged.

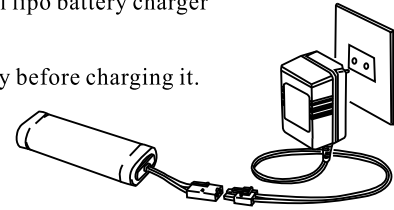

2 Turn on your radio control and radio system on your vehicle

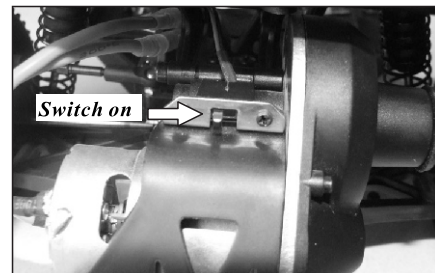
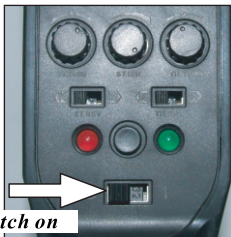

3 Checking throttle trim dial

To fine tune the throttle's neutral point turn the throttle trim dial.

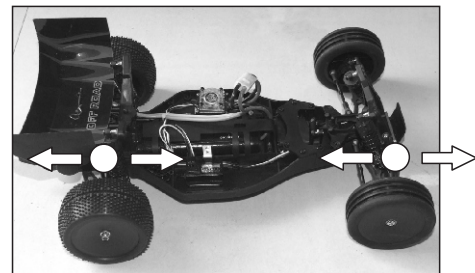
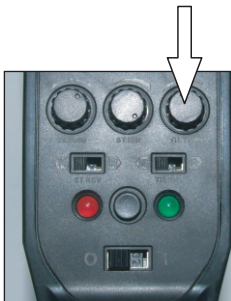

While the wheels begin to move, gently turn the throttle trim dial until no chirring sound is heard from ESC.

4 Checking steering performance

- Turn the steering control wheel to the right and your model turns right.
- Turn the steering control wheel to the left and your model turns left.

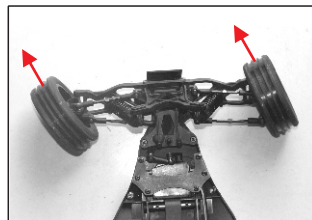
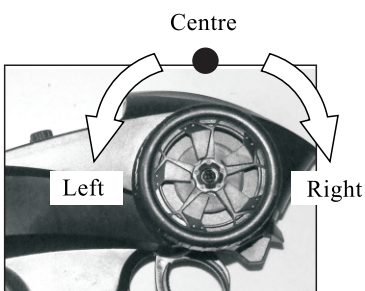

The front wheels point left.

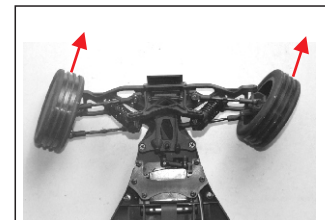

The front wheels point right.

The turning angle of the front wheels is subject to change in response to different turning angles on the steering control wheel of your transmitter.

5 Checking trigger control

- Pull the trigger back to accelerate, release it to decelerate, and push it to brake.
- Return the trigger to Neutral and then push it at a second time to permit your car to go backwards.
- To stop running your vehicle leave the trigger unattached at Neutral.

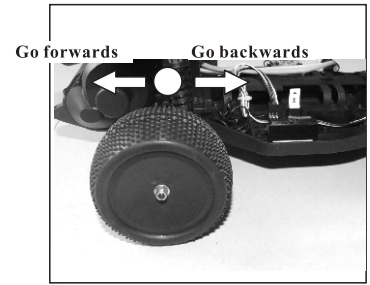
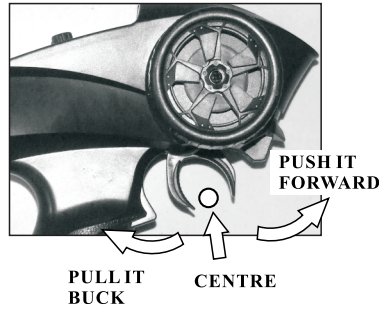

6 Adjusting steering trim dial

To keep the front wheels aligned turn the steering trim dial.

The front wheels are straightly aligned.

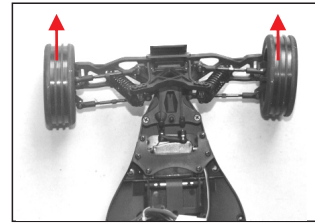
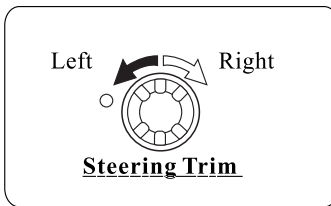

To allow the front wheel to point straight turn the steering trim dial gently whilst decelerating your car.

7 Tuning steering dual rate dial

Turn the front wheel at a free angle before you attempt to tune the Steering Dual Rate Control Dial.

Decrease ← → Increase

- This dial adjusts the overall travel of the steering servo.
- Turn the dial clockwise for maximum steering.
- Turn the dial anti-clockwisely to reduce the steering level.
- Set the Steering Dual Rate Control Dial to Minimum first.
- To set the desired steering level increase it again whilst decelerating your vehicle.

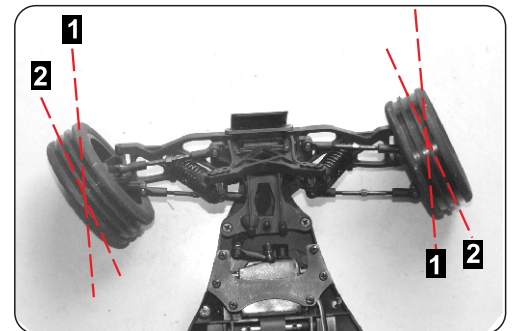

- 1.Low Steering Level
- 2.High Steering Level

8 To stop running your vehicle



Note: To stop running your vehicle you should turn off the receiver before turning the radio controller off.

1. Turn off the receiver on your vehicle.

2. Turn off your radio controller.

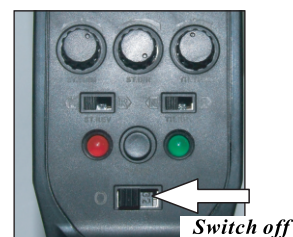
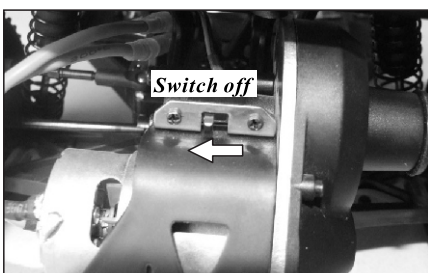

3. Remove the battery pack

Remove the battery pack from your vehicle if not in use for a long period of time.

Store them separately.

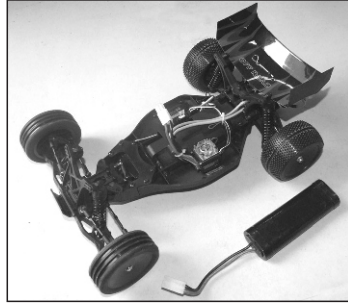

4. Check all parts

Check all parts and immediately perform the measures of maintenance and/or replacement if necessary.

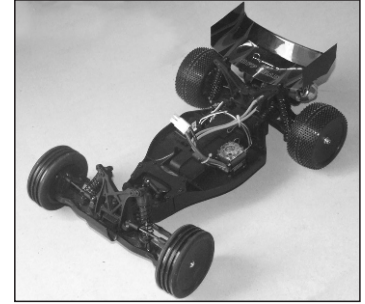

5. Maintenance

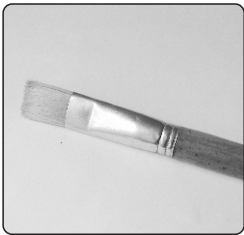

Clean all dust out with a soft brush and dry your car off with a soft cloth.

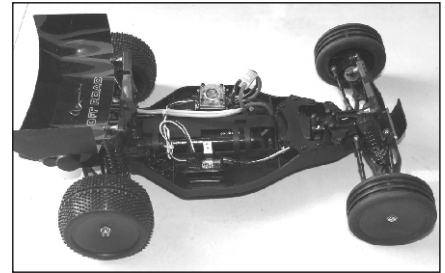

TROUBLESHOOTING LIST

A. The vehicle does not work at all.

1. Check to see if the radio controller and the receiver on the car are on.
2. Check to see if the receiver and the radio controller are properly bound.
3. Adjust throttle trim on radio controller.
4. Replace batteries.

B. The vehicle runs slow.

1. Remove the battery and charge it.
2. Make sure the vehicle is geared properly and the pinion and spur gear are over tightened.
3. Clean all bushings or ball bearings.
4. Check for stripped or dirty gears.

C. The throttle works, but it can not steer.

1. Check if the servo feels jammed, try centering it by hand gently.
2. Check the whole steering system.

D. It steers, however, throttle is uncontrollable.

1. Adjust the throttle rim.
2. Replace the batteries.

E. The vehicle runs noisily.

1. Check gear mesh between spur gear and pinion.
2. Check for stripped and/or dirty gears.
3. Clean and oil the bushings or ball bearings.

TO TUNE YOUR VEHICLE

Your model can be customized to enhance speed and performance. Simple adjustment and easily maintained setting will assure optimum operation and performance. When making adjustments, do so only in small increments and always check for other parts of the vehicle that are affected. Many after market options are available to make your R/C vehicle faster and stronger. Please read the section carefully and it always make sure you write down your base settings in case you need to refer to them at a later date.

Front steering toe angle

The front steering toe angle has a dramatic on how your car performs and how your tires wear. You can have toe-in, zero toe or toe-out. This can be adjusted by turning the front turning linkage set with an adjustable wrench.

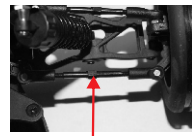
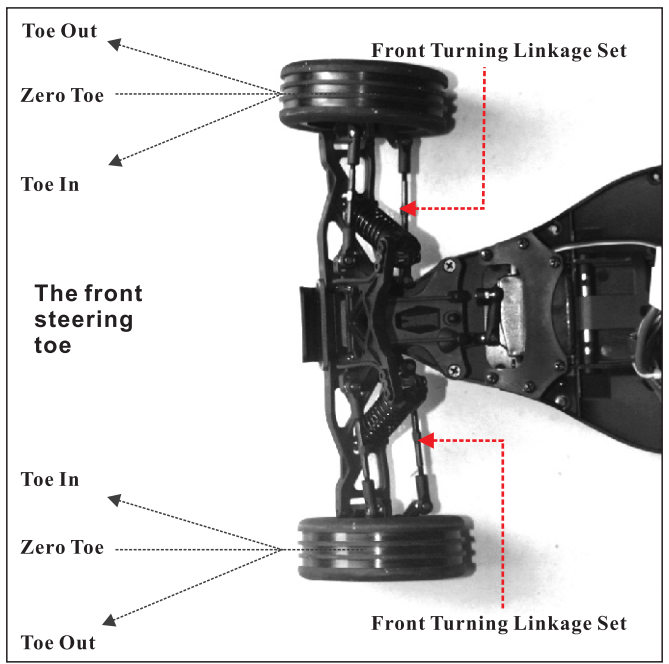

To adjust front turning linkage bar

Toe-in will be less reactive and cause the vehicle to under steer(the front wheels push straight on while turning).

This can be advantageous for operators struggling to get to grips with the driving of the vehicle.

Toe-out will be more aggressive on the steering response especially on small steering inputs. This will make the car want to over steer(rear wheels slide on small steering inputs).This is useful as a race tuning aid to gain extra steering.

Zero toe will make the front wheels run straight and make the car very neutral. Tire wear will also be reduced and the vehicle will feel easier to drive.

Camber Adjustment

Camber can be adjusted on all 4 wheels of the car. You can have negative camber or positive camber which will affect the contact patch of the tire both statically and while cornering. Camber is mainly used to control the wear of the tire. You should adjust the camber to equal the wear all across the surface of the tire. Camber is adjusted by the upper link turnbuckle linking the wheel to the chassis front and rear.

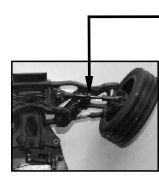

Front Upper Link Turnbuckle

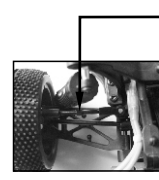

Rear Upper Link Turnbuckle

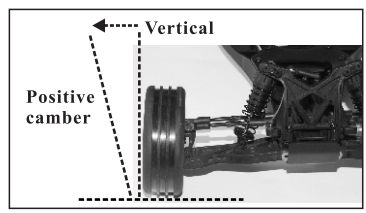

This is an example of positive camber.

This is when the bottom of the wheel is closer to the centre of the car compared to the top of the wheel. Positive camber will give less contact area in the corner and less grip. Excessive amounts will cause less grip and uneven wear.

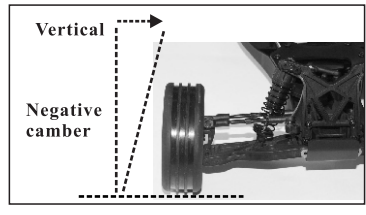

This is an example of negative camber.

This is when the top of the wheel is closer to the centre of the car compared to the bottom of the wheel. Negative camber will give more contact area in the corner and more grip. Excessive amounts will cause less grip and uneven wear.

SPARE PARTS-1

<p>KB-61001</p>  <p>Chassis</p>	<p>KB-61002</p>  <p>Front Bottom Plate+Rear Bottom Plate +Rear Shock Tower Mount +Front Suspension Mount+Front Suspension Pin Brace Pad</p>	<p>KB-61003</p>  <p>Front Top Mount+ Servo Arm+ Servo Mount</p>	<p>KB-61004</p>  <p>Front Top Steering Mount</p>
<p>KB-61005</p>  <p>Diff Gear Housing</p>	<p>KB-61006</p>  <p>Diff. Main Gear+Idler Gear+ Diff. Pinion Gear+Diff. Large Bevel Gears + Diff. Small Bevel Gears+Diff. Inner Mount</p>	<p>KB-61007</p>  <p>Front Bumper+Motor Guard</p>	<p>KB-61008</p>  <p>Gear Cover+Access Plug (Silicone Rubber)</p>
<p>KB-61009</p>  <p>Rear Suspension Pivot Block Set (A pair)</p>	<p>KB-61010</p>  <p>Battery Holder+ Lock Pins+ Load Spring+Mount+Cap Head Screw 2*8mm</p>	<p>KB-61011</p>  <p>Front Shock Tower+ Rear Shock Tower</p>	<p>KB-61012</p>  <p>Steering Mount Assembly+Steering Ackerman Plate</p>
<p>KB-61013</p>  <p>Front Lower Suspension Arms (Left/right)</p>	<p>KB-61014</p>  <p>Rear Lower Suspension Arms (Left/right)</p>	<p>KB-61015</p>  <p>Steering Hubs(Left/right)</p>	<p>KB-61016</p>  <p>Front Uprights(Left/right)</p>
<p>KB-61017</p>  <p>Rear Uprights(Left/right)</p>	<p>KB-61018</p>  <p>Enforced Pads Complete (Thick/thin)</p>	<p>KB-61019</p>  <p>Wing Stay + Front Body Post</p>	<p>KB-61020</p>  <p>Off Road Tyres (Front)+Sponge Insert</p>

Note: Part Images may vary from received parts.

SPARE PARTS-2

<p>KB-61021</p>  <p>Off Road Tyres (Rear)+Sponge Insert</p>	<p>KB-61022</p>  <p>Off Road Rims(Front)</p>	<p>KB-61023</p>  <p>Off Road Rims(Rear)</p>	<p>KB-61024</p>  <p>Off Road Wheels Complete(Front)</p>
<p>KB-61025</p>  <p>Off Road Wheels Complete(Rear)</p>	<p>KB-61026</p>  <p>Slipper Load Spring+Slipper Spacer+Nut M3+Slipper Bushing+Slipper Washer</p>	<p>KB-61027</p>  <p>Slipper Back Plate+Slipper Pad</p>	<p>KB-61028</p>  <p>Steering Mount Assembly (Steering Bush, Servo saver load Spring, Steering Pad)</p>
<p>KB-61029</p>  <p>Rear CVD Axles</p>	<p>KB-61030</p>  <p>Diff. Outdrives+ Countersunk Screw 2*2.5mm</p>	<p>KB-61031</p>  <p>Front Axles + E-Clips 3mm</p>	<p>KB-61032</p>  <p>Motor Plate</p>
<p>KB-61033</p>  <p>Front Suspension Pin Brace</p>	<p>KB-61034</p>  <p>Rear Drive Shafts (L=approx.70.6mm)</p>	<p>KB-61035</p>  <p>Slipper Shaft+Transmission Upper Gear Shaft</p>	<p>KB-61036</p>  <p>Steering Hub Hinge Pins (L=approx. 23mm)</p>
<p>KB-61037</p>  <p>Front Lower Suspension Hinge Pin -Outside(L=approx.26mm)</p>	<p>KB-61038</p>  <p>Rear Lower Suspension Hinge Pin -Outside(L=approx.27.3mm)</p>	<p>KB-61039</p>  <p>Front Lower Suspension Hinge Pin -inside(L=approx. 36.5mm)</p>	<p>KB-61040</p>  <p>Rear Lower Suspension Hinge Pin -inside(L=approx.48.5mm)</p>















Note: Part Images may vary from received parts.

SPARE PARTS-3

<p>KB-61041</p>  <p>Switch Mount</p>	<p>KB-61042</p>  <p>Wheel Washers</p>	<p>KB-61043 Inner Hole: 3.25mm (for brushed version)</p>  <p>Motor Pinon (21T)+Set Screw 3*3mm</p>	<p>KB-61044 Inner Hole: 3.25mm (for brushed version)</p>  <p>Motor Pinon (23T)+Set Screw 3*3mm</p>
<p>KB-61045 Inner Hole: 3.25mm (for brushed version)</p>  <p>Motor Pinon (27T)+Set Screw 3*3mm</p>	<p>H180 Inner Hole: 5mm (for brushless version)</p>  <p>Motor Pinon (19T)+Set Screw 3*3mm</p>	<p>H181 Inner Hole: 5mm (for brushless version)</p>  <p>Motor Pinon (21T)+Set Screw 3*3mm</p>	<p>H182 Inner Hole: 5mm (for brushless version)</p>  <p>Motor Pinon (23T)+Set Screw 3*3mm</p>
<p>KB-61046</p>  <p>Front Shock Absorbers</p>	<p>KB-61047</p>  <p>Rear Shock Absorbers</p>	<p>KB-61048</p>  <p>Front/Rear Upper Adjustable Linkage Assembly (Different adjustment to front and rear ones can be measured by users)</p>	<p>KB-61049</p>  <p>Front Steering Adjustable Linkage Assembly</p>
<p>KB-61050</p>  <p>Servo Linkage Assembly</p>	<p>KB-61051</p>  <p>Diff. Complete+ Idler Gear+ Diff. Pinion Gear + Ball Bearing (5*10*4)</p>	<p>KB-61052</p>  <p>Spur Gear (77T)</p>	<p>KB-61053</p>  <p>2.5*22mm 9*14*0.2mm 3*7*0.2mm</p> <p>Diff. Pins+Shims</p>
<p>KB-61054</p> <p>6PCS</p>  <p>Ball Bearings (3*6*2.5mm)</p>	<p>KB-61055</p> <p>4PCS</p>  <p>Buggy Wing Pins</p>	<p>H001</p> <p>8PCS</p>  <p>Ball Stud.φ 4.8*4.9</p>	<p>H002</p> <p>6PCS</p>  <p>Lock Nut M3</p>

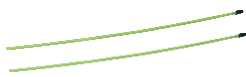



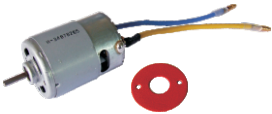
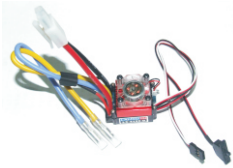
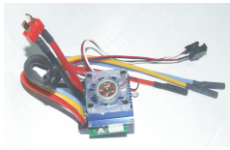





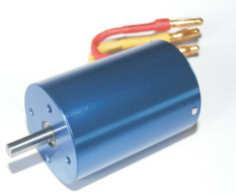









Note: Part Images may vary from received parts.

SPARE PARTS-4

<p>H003</p> <p>6PCS</p>  <p>Flange Lock Nut M4</p>	<p>H008</p> <p>6PCS</p>  <p>Ball Bearings(5*10*4)</p>	<p>H009</p> <p>4PCS</p>  <p>Ball Bearings(10*15*4)</p>	<p>H013</p> <p>8PCS</p>  <p>Shock Ball Pivot. ϕ 4.8</p>
<p>H017</p> <p>6PCS</p>  <p>Lock Nut M2.5</p>	<p>H020</p> <p>12PCS</p>  <p>Big Body Clip A/B</p>	<p>H021</p> <p>12PCS</p>  <p>Small Body Clip A/B</p>	<p>H022</p> <p>8PCS</p>  <p>Wheel Hex. Pin (ϕ 2*10mm)</p>
<p>H040</p> <p>8PCS</p>  <p>Shock Ball Stud.</p>	<p>H152</p> <p>8PCS</p>  <p>E-clip 4mm</p>	<p>H154</p> <p>8PCS</p>  <p>E-clip 3mm</p>	<p>P010</p> <p>8PCS</p>  <p>Zip Tie(Big)</p>
<p>P011</p> <p>8PCS</p>  <p>Zip Tie(Small)</p>	<p>P019</p> <p>2PCS</p>  <p>Receiver Antenna Pipe</p>	<p>P100</p> <p>8PCS</p>  <p>Body Post Pad</p>	<p>E001</p> <p>Torque:3.2Kg</p>  <p>3.2kg Servo (LS-3003) + Mount</p>
<p>E710</p>  <p>Receiver(2.4Ghz)</p>	<p>E012</p>  <p>RC 540 Motor (20000rpm)</p>	<p>E185</p>  <p>Brushed ESC w/cooling fan (100A, max. Voltage: 7.4v)</p>	<p>E186</p>  <p>Brushless ESC (7.4v-12v, 90A), w/cooling fan attached Compatible for sensor/sensorless brushless motor</p>









Note: Part Images may vary from received parts.

SPARE PARTS-5

<p>E188</p>  <p>Brushless Motor</p>	<p>T001</p>  <p>Large Cross Wrench</p> <p>Φ 8mm Φ 9mm Φ 10mm Φ 12mm</p>	<p>T002</p>  <p>Small Cross Wrench</p> <p>Φ 2mm Φ 2.5mm Φ 3mm Φ 4mm</p>	<p>S002</p> <p>12PCS</p>  <p>Round Head Self Tapping Screw 3*12mm</p>
<p>S003</p> <p>12PCS</p>  <p>Round Head Self Tapping Screw 3*8mm</p>	<p>S004</p> <p>12PCS</p>  <p>Round Head Self Tapping Screw 3*18mm</p>	<p>S010</p> <p>12PCS</p>  <p>Countersunk Self Tapping Screw 3*12mm</p>	<p>S011</p> <p>12PCS</p>  <p>Countersunk Self Tapping Screw 2*15mm</p>
<p>S016</p> <p>12PCS</p>  <p>Grub Screw 3*3mm</p>	<p>S018</p> <p>12PCS</p>  <p>Round Head Self Tapping Screw 2.6*8mm</p>	<p>S019</p> <p>12PCS</p>  <p>Countersunk Self Tapping Screw 3*8mm</p>	<p>S020</p> <p>12PCS</p>  <p>Countersunk Self Tapping Screw 2.6*8mm</p>
<p>S024</p> <p>12PCS</p>  <p>Countersunk Self Tapping Screw 3*10mm</p>	<p>S030</p> <p>12PCS</p>  <p>Round Head Self Tapping Screw 3*10mm</p>	<p>S031</p> <p>12PCS</p>  <p>Cap Head Inner Hex. Screw 2*8mm</p>	<p>S034</p> <p>12PCS</p>  <p>Countersunk Screw 2*2.5mm</p>
<p>S060</p> <p>12PCS</p>  <p>Round Head Screw 2.5*12mm</p>	<p>S065</p> <p>12PCS</p>  <p>Round Head Screw 3*25mm</p>	<p>S085</p> <p>12PCS</p>  <p>Round Head Self Tapping Screw 3*15mm</p>	<p>S100</p> <p>12PCS</p>  <p>Round Head Screw 2.5*8mm</p>

Note: Part Images may vary from received parts.

SPARE PARTS-6

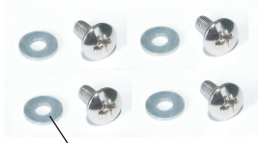
<p>S104</p> <p>12PCS</p>  <p>Round Head Screw 3*10mm</p>	<p>S120</p> <p>12PCS</p>  <p>Round Head Flange Self Tapping Screw 2.3*4mm</p>	<p>S121</p> <p>12PCS</p>  <p>Countersunk Screw 2.5*17mm</p>	<p>S122</p> <p>12PCS</p>  <p>Small Round Head Screw 3*10mm</p>
<p>S123</p> <p>12PCS</p>  <p>Round Head Screw 3*18.5mm</p>	<p>S124</p> <p>12PCS</p>  <p>Round Head Screw 2.5*22mm</p>	<p>S125</p> <p>12PCS</p>  <p>Cap Head Screw 3*30mm</p>	<p>S126</p> <p>12PCS</p>  <p>Cap Head Screw 3*33.5mm</p>
<p>S127</p> <p>4PCS</p>  <p>Round Head Screw 3*8mm +Shims</p>			

Note: Part Images may vary from received parts.

OPTIONAL PARTS

<p>KB-62113</p>  <p>CNC Aluminum Steering Hubs</p>	<p>KB-62114</p>  <p>CNC Aluminum Steering Hub Mount</p>	<p>KB-62112</p>  <p>CNC Aluminum Rear Hubs</p>	<p>KB-61110</p>  <p>Adjustable Rear Suspension Mount Kit (CNC parts+ Carbon Fibre Part)</p>
<p>KB-62118</p>  <p>CNC Aluminum Front Suspension Mount</p>	<p>KB-61111</p>  <p>Rear CVD Shaft (Buggy)</p>	<p>KB-61112</p>  <p>Rear CVD Shaft (Truggy)</p>	<p>KB-62220</p>  <p>Carbon Fibre Front Steering Top Plate</p>
<p>KB-61115</p>  <p>Wheelie + Screw</p>	<p>KB-61118</p>  <p>Metal Gears Complete</p>		

HOW TO INSTALL THE REAR SUSPENSION RE-LOCATION KIT?

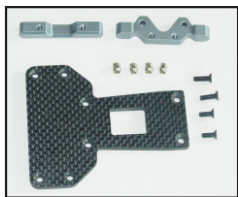

- The part consists of:**
- 1) Carbon fibre rear mount
 - 2) Aluminum rear suspension inside and outside mount
 - 3) 2pcs of countersunk screws (3*10mm) and 2pcs of countersunk screws (3*8mm)
 - 4) 4pcs of ball studs

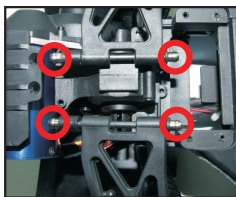

Remove the old plastic rear suspension mount and install 4pcs of ball studs as show. (Note: Do not drop any screws as they might be in use in further assembly)

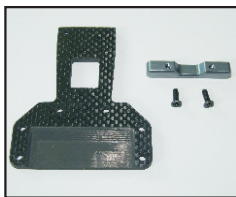

Firstly collect the carbon fibre rear mount, 2pcs of countersunk screws(3*10mm) and aluminum rear suspension inside mount.

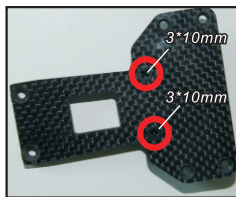

Install the aluminum rear suspension inside mount to the carbon fibre rear mount with the screws (3*10mm) as shown. (The aluminum rear suspension inside mount is installed on the back of the photo which shows only the mounting of the two screws)

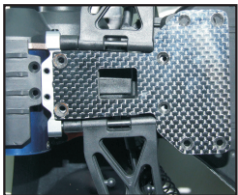

Install the assembled carbon fibre rear mount to the suspension with the help of aluminum rear suspension outside mount and 2pcs of screws(3*8mm). Lock all screws as shown. (During the assembly, the screws from stock version can be all used again except 2pcs of screws 3*8mm which are used to lock the motor guard to aluminum rear suspension outside mount as shown.)

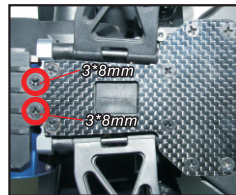

What is the use of this part?

After this part is installed, the rear suspension unit is replaced a little backwards. It is not to allow the car to easily run with front wheels standing up that this optional part is designed.

Note: Part Images may vary from received parts.

FRONT/REAR SHOCK ASSEMBLY

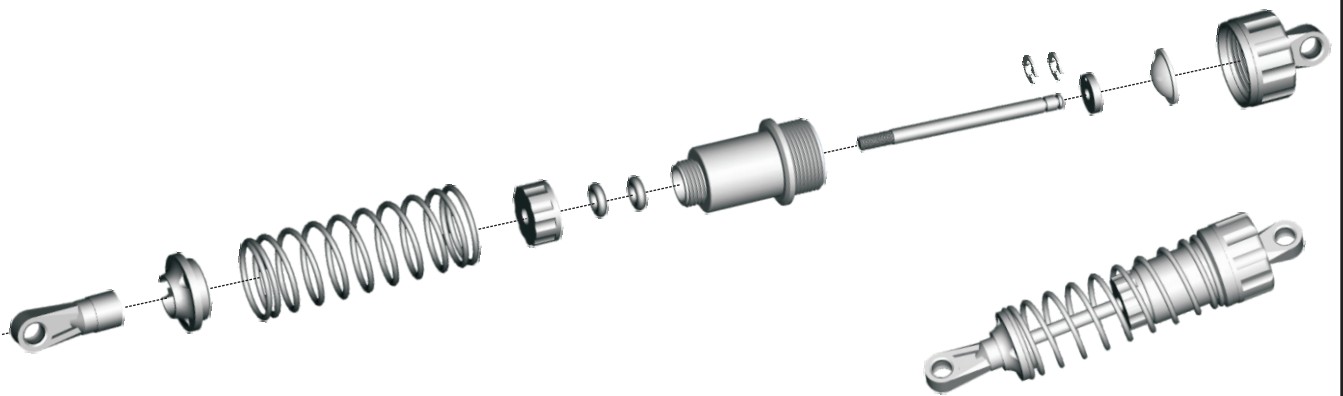

BATTERY COVER INSTALLATION

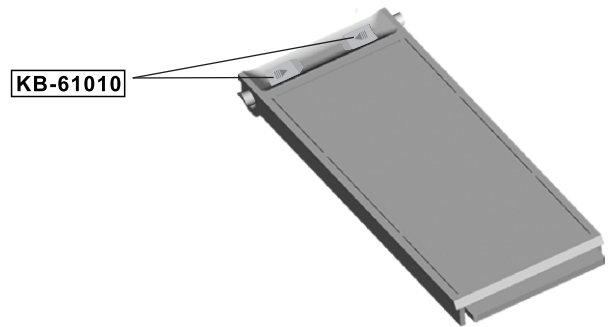
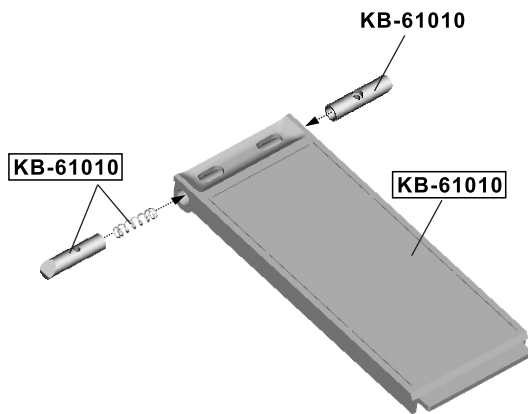

Locked with the screw (S031)

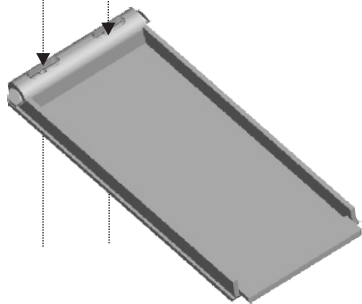

Place the battery cover and press it until it snaps together with the chassis.

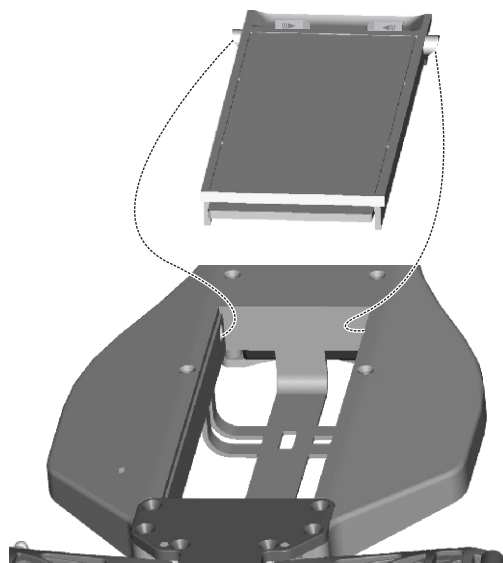

FRONT STEERING ASSEMBLY

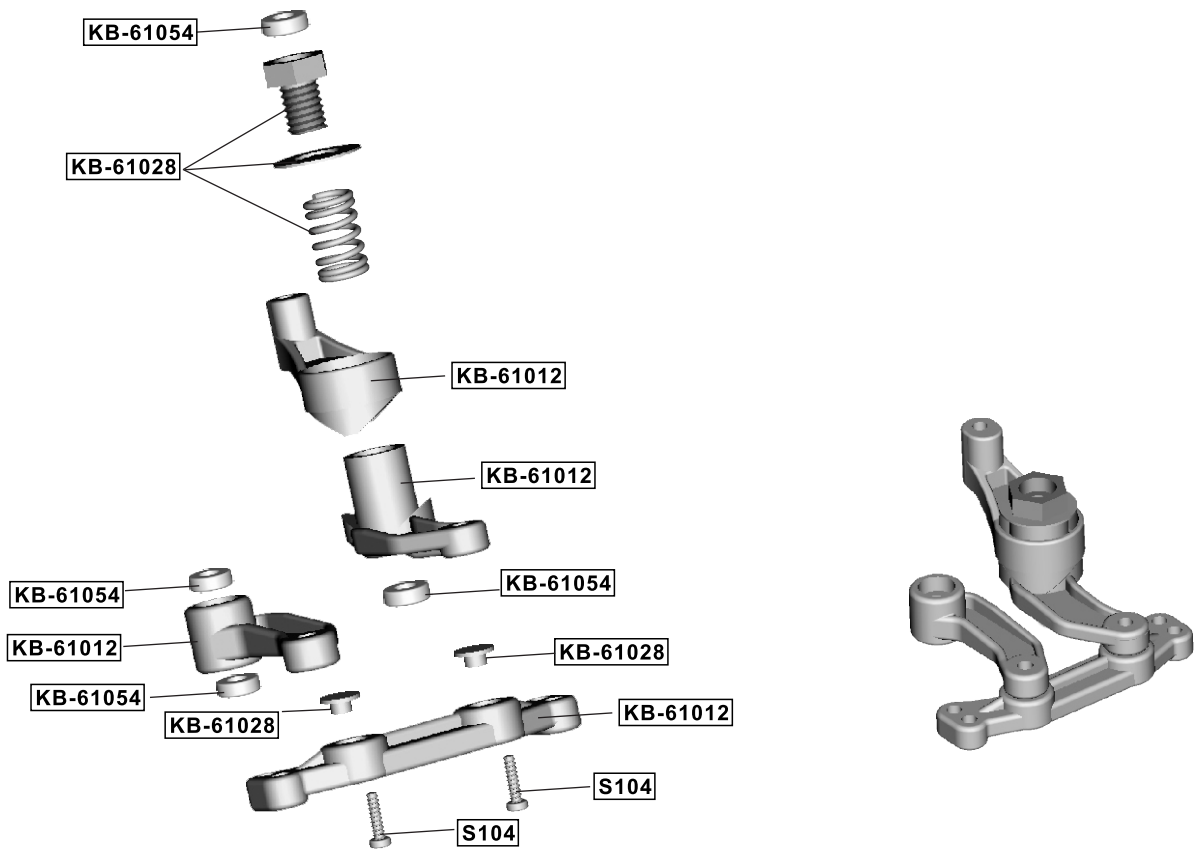

2WD REAR DIFF. ASSEMBLY-1

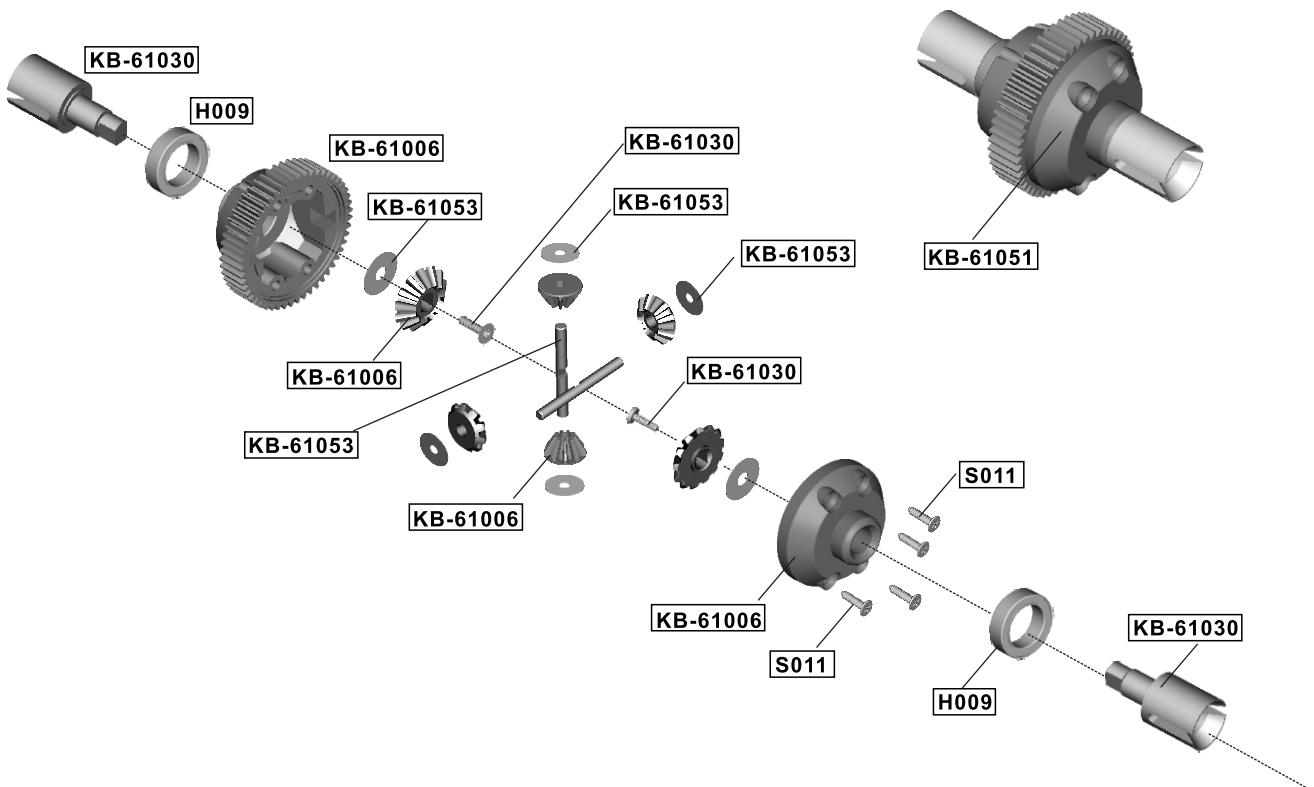

Specifications and/or images are subject to change without prior notification.

2WD REAR DIFF. ASSEMBLY-2

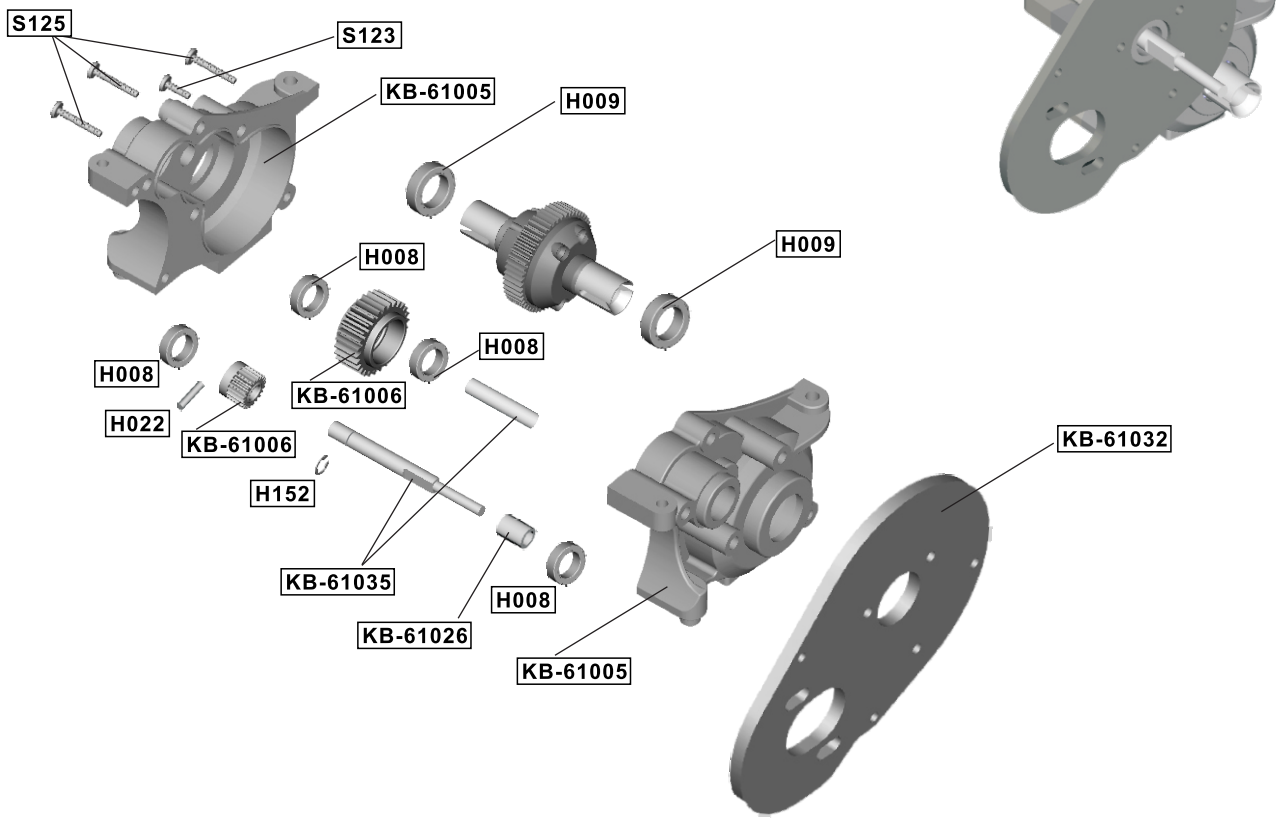

MOTOR INSTALLATION

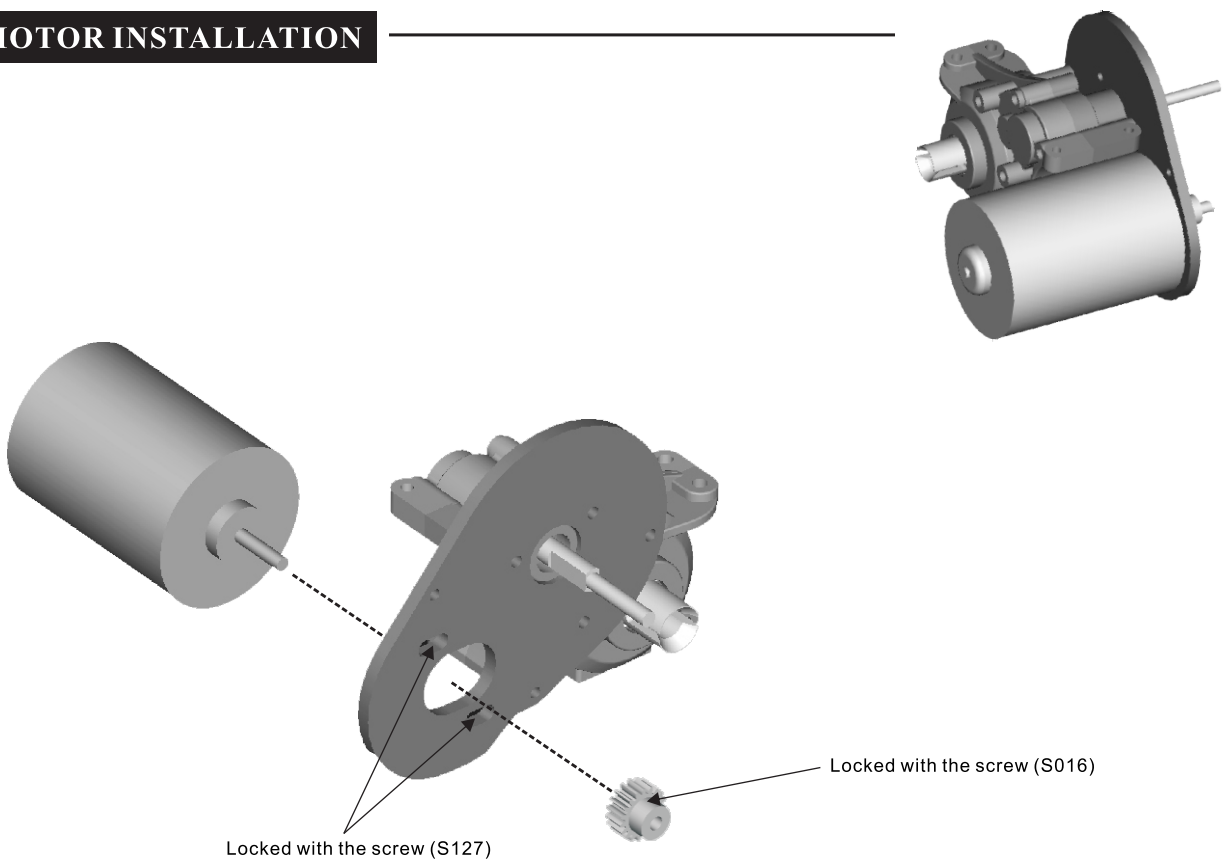

STEERING HUB/FRONT UPRIGHT INSTALLATION -LEFT SIDE

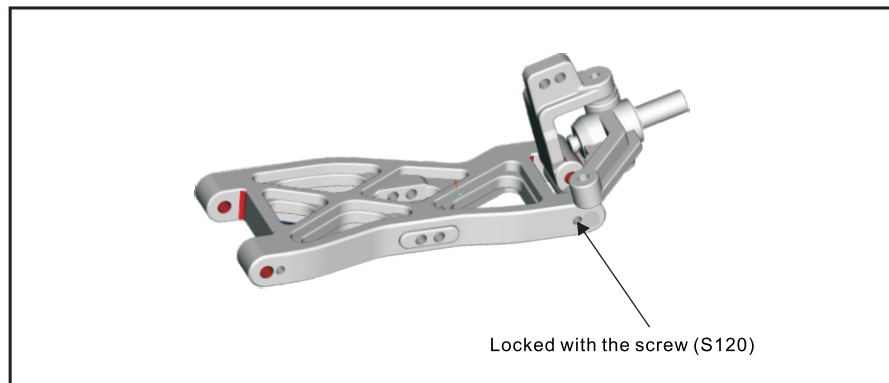
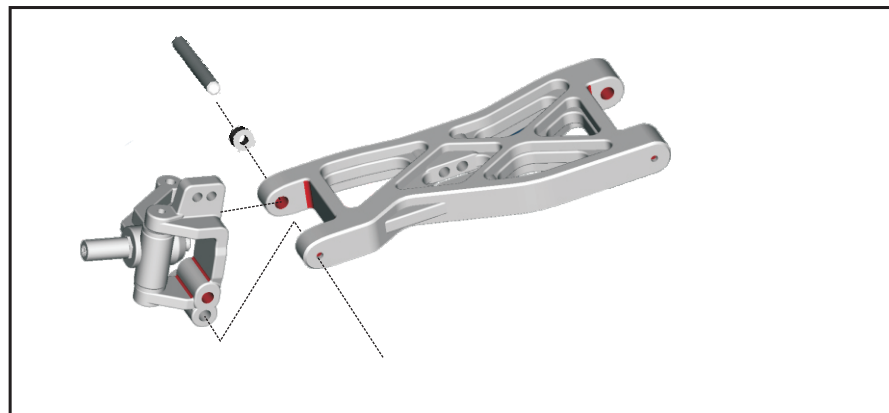
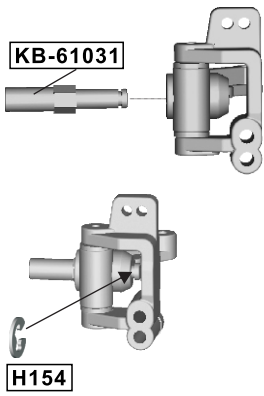
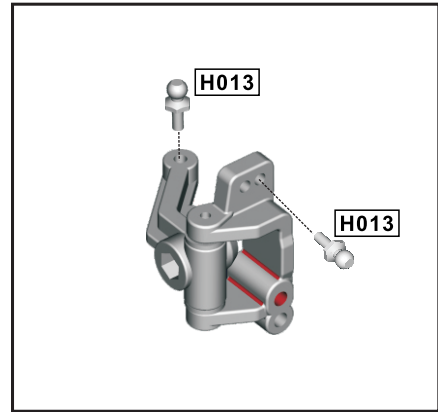
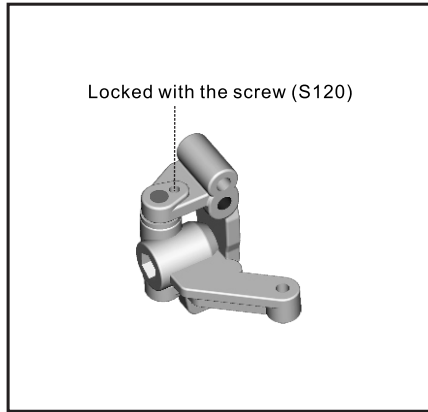
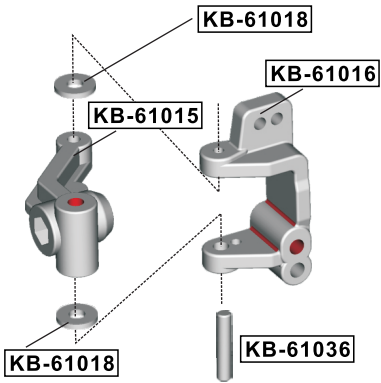

STEERING HUB/FRONT UPRIGHT INSTALLATION -RIGHT SIDE

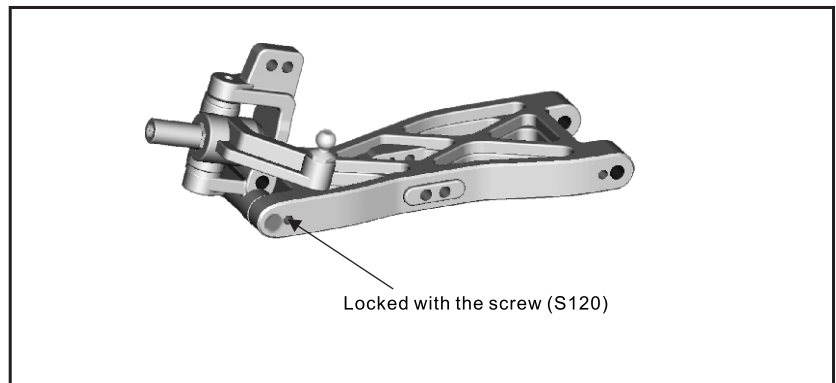
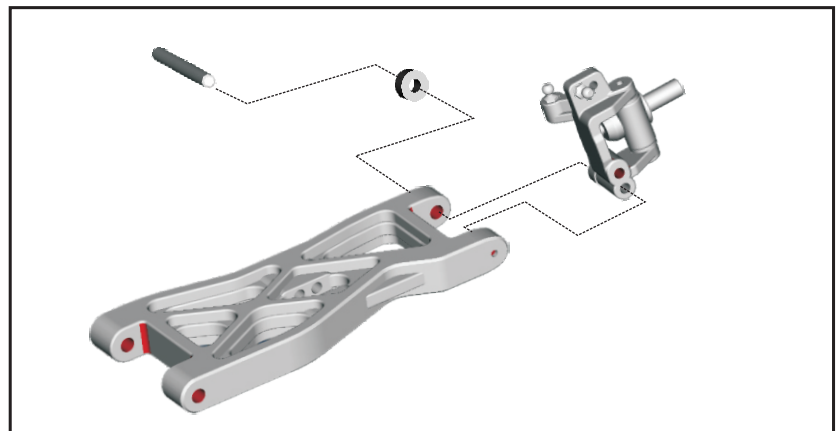
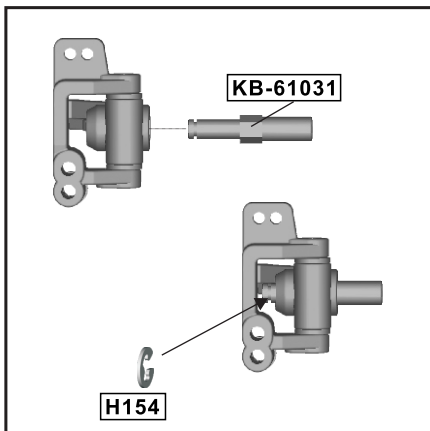
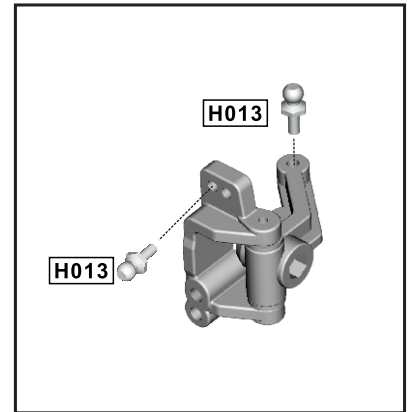
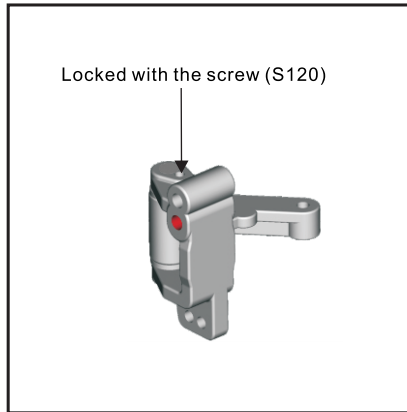
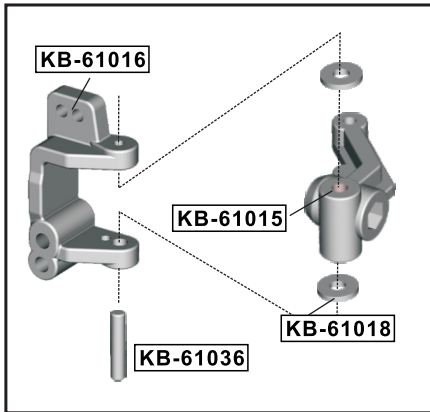

REAR UPRIGHT INSTALLATION

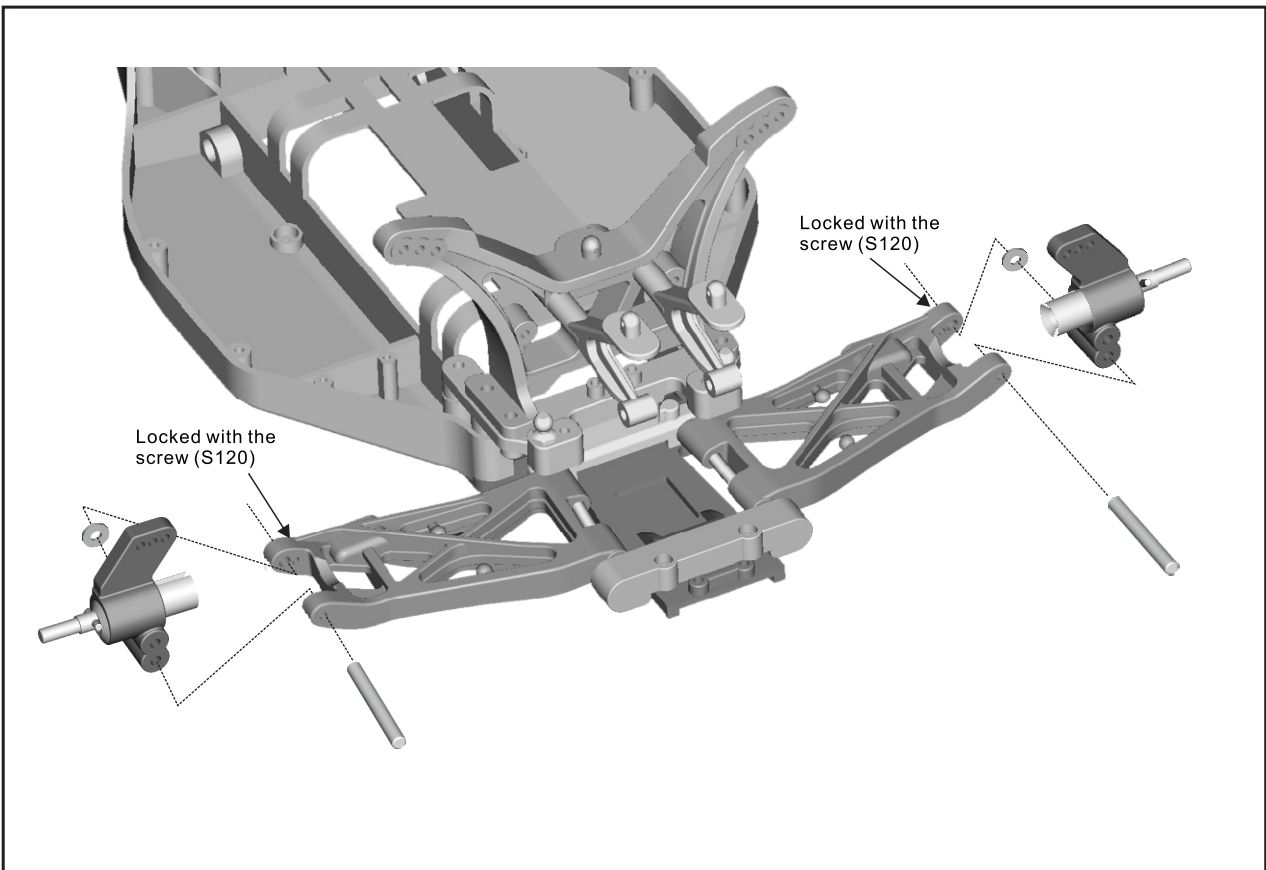
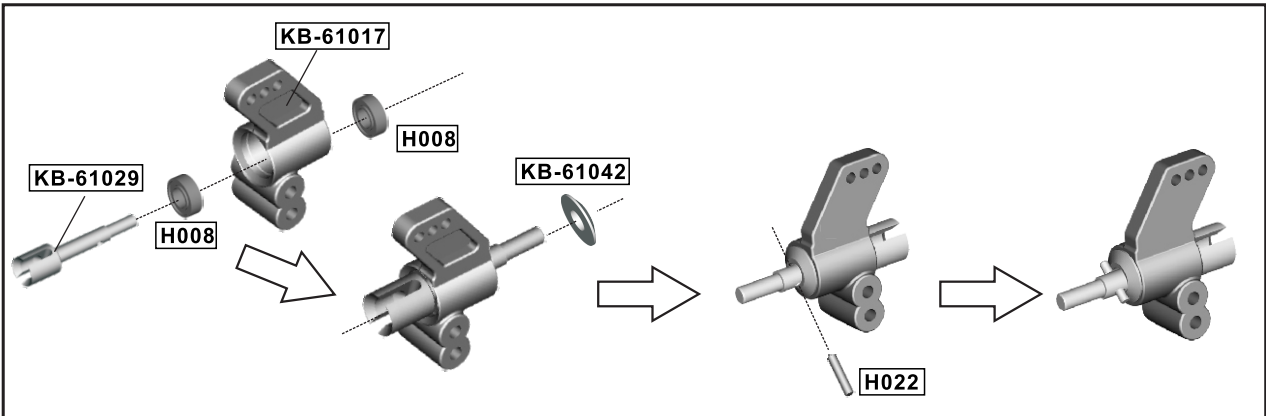
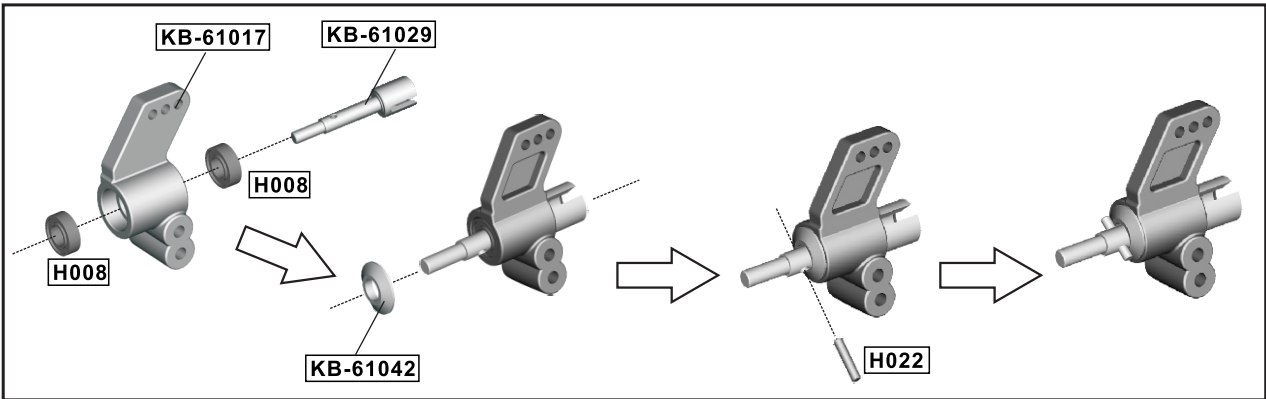

SPUR GEAR /SLIPPER CLUTCH INSTALLATION

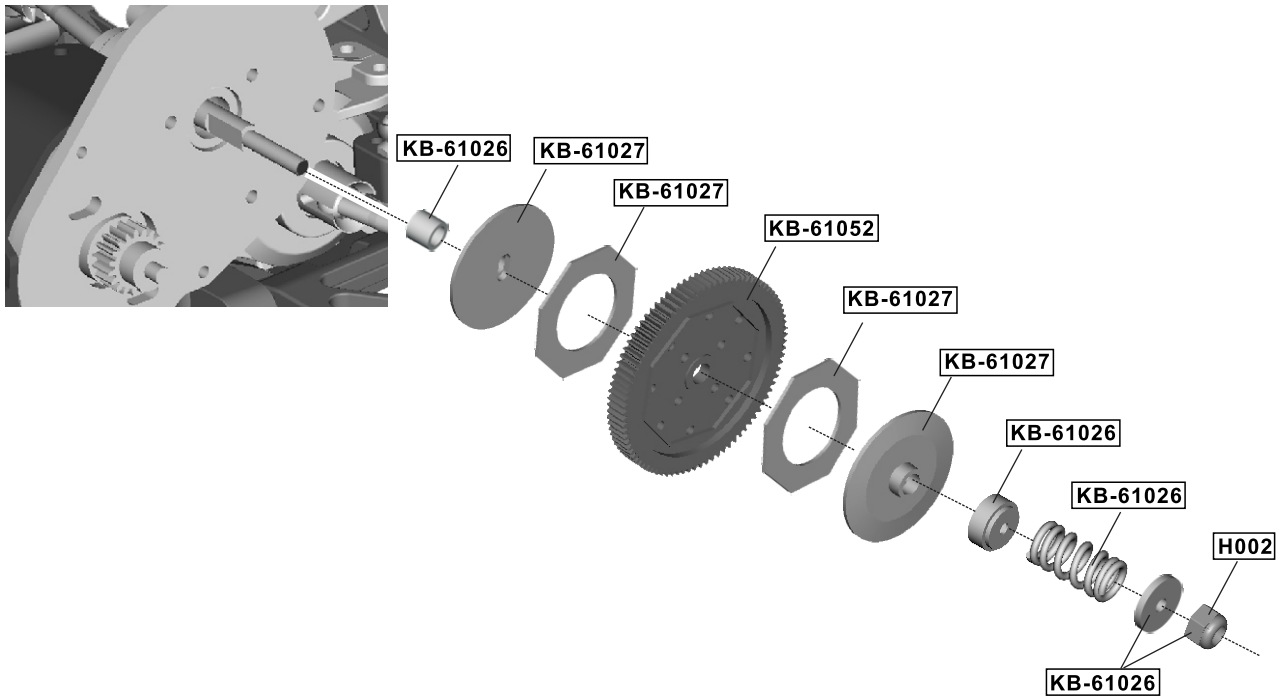

Install the spur gear and slipper clutch as show. Tighten the lock nut with a cross wrench once installed.
 A) If there is too much slippery, please loosen it for smoother power delivery.
 B) For high grip performance, please tighten it for quicker throttle response.
 Our standard adjustment is to allow the slipper gear not to slip when it lands on the ground after jumping.

SERVO INSTALLATION

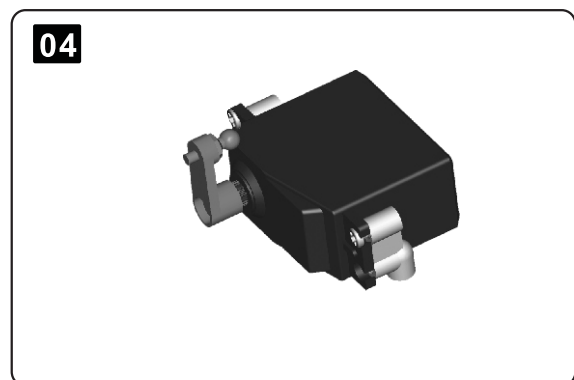
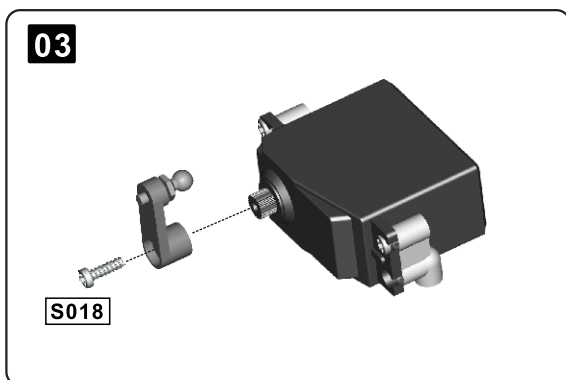
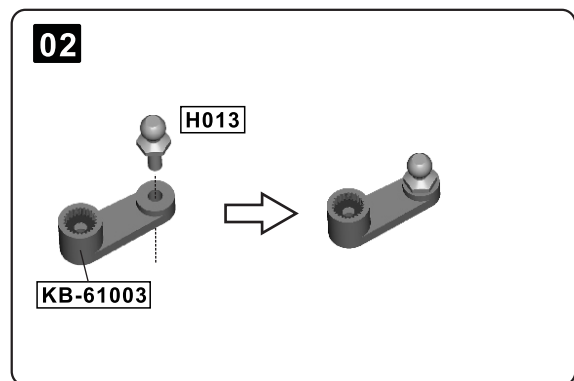
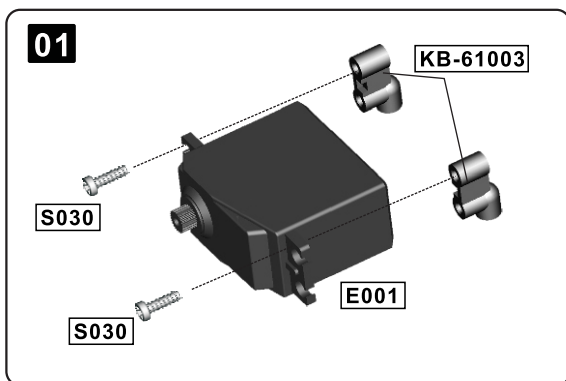

1:10TH SCALE 2WD ELECTRIC POWERED OFF ROAD BUGGY

EXPLODED DIAGRAM

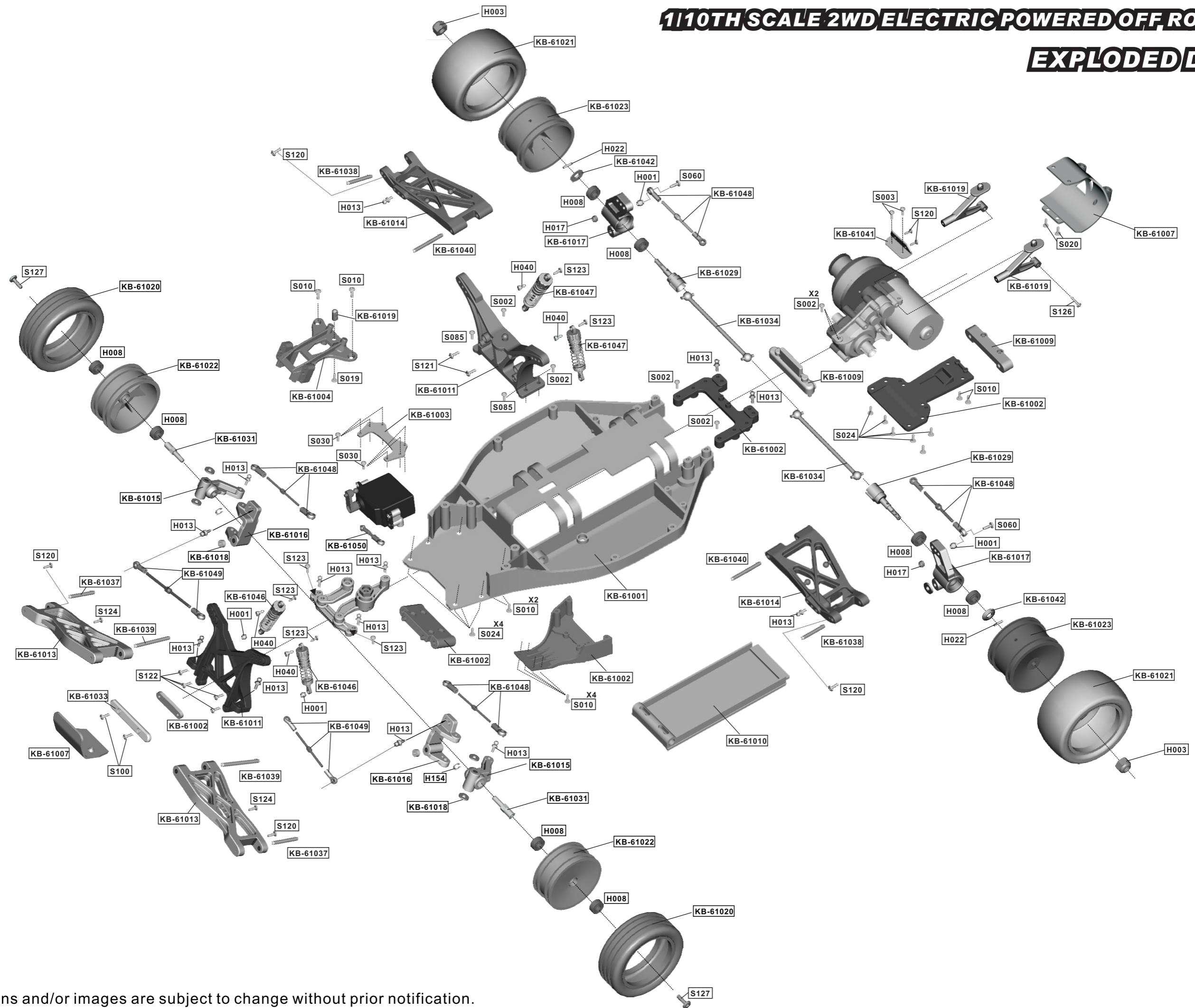

Specifications and/or images are subject to change without prior notification.

Please read this manual carefully before assembling and or disassembling your vehicle.

INSTRUCTION MANUAL

1/10TH SCALE 2WD ELECTRIC POWERED OFF ROAD BUGGY

TWO WHEEL DRIVE RACING

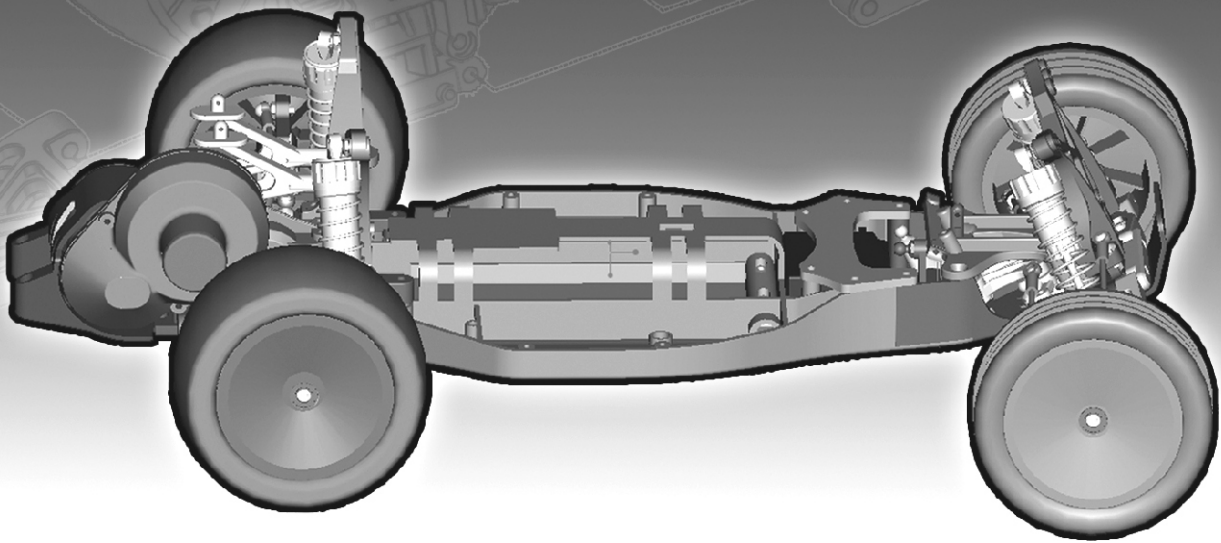

Thank for purchasing our product.

This product is an authentic remote controlled vehicle (RC vehicle). It is not a toy.

Read and understand this instruction manual thoroughly before operating the vehicle.

If you are not familiar with RC vehicles, we recommend that seek out RC experts for reliable advice.

1/10TH SCALE TWO WHEEL DRIVE ELECTRIC OFF ROAD BUGGY

WARNINGS

- This R/C vehicle is intended for persons over 14 years of age. Children under 14 years of age should only operate this car under adult supervision.
- To avoid losing control of your car, do not operate near other electric remote controlled products.
- Please operate your vehicle in a spacious area. Never operate your vehicle in crowded street.
- This product is fully assembled at factory. We do not take any responsibility for damage and/or accidents that occur as the result of custom modifications and/or incorrect operation.